

DL1740E/DL1740EL
Digital Oscilloscope
Serial Bus Signal Analysis Function
USER'S MANUAL

Thank you for purchasing the DL1740E/DL1740EL Digital Oscilloscope with the Serial Bus Signal Analysis Function (/F5 option*). This user's manual describes only the serial bus signal analysis function (I²C Bus Signal Analysis Function, and SPI Bus Signal Analysis Function. For information about other functions, operating procedures, and handling precautions of the DL1740E/DL1740EL, see the following manuals.

Manual Title	Manual No.	Description
DL1720E/DL1740E/DL1740EL User's Manual	IM 701730-01E	Explains all functions and procedures of the DL1720E/DL1740E/DL1740EL excluding the communication functions.
DL1720E/DL1740E/DL1740EL Operation Guide	IM 701730-02E	Explains briefly the functions and basic operations.
DL1720E/DL1740E/DL1740EL Communication Interface User's Manual (CD-ROM)	IM 701730-17E	Describes the communication interface functions.

* /F5 option: Model with the I²C Bus Signal Analysis Function and SPI Bus Signal Analysis Function

Notes

- The contents of this manual are subject to change without prior notice as a result of continuing improvements to the instrument's performance and functions. The figures given in this manual may differ from those that actually appear on your screen.
- Every effort has been made in the preparation of this manual to ensure the accuracy of its contents. However, should you have any questions or find any errors, please contact your nearest YOKOGAWA dealer.
- Copying or reproducing all or any part of the contents of this manual without the permission of Yokogawa Electric Corporation is strictly prohibited.
- The TCP/IP software of this product and the document concerning the TCP/IP software have been developed/created by YOKOGAWA based on the BSD Networking Software, Release 1 that has been licensed from the University of California.

Trademarks

- Microsoft, MS-DOS, Windows, Windows NT are either registered trademarks or trademarks of Microsoft Corporation in the United States and/or other countries.
- Adobe and Acrobat are trademarks of Adobe Systems incorporated.
- UNIX is either a registered trademark or trademark of The Open Group in the United States and/or other countries.
- For purposes of this manual, the TM and ® symbols do not accompany their respective trademark names or registered trademark names.
- Other company and product names are trademarks or registered trademarks of their respective companies.

Revisions

- 1st edition: July 2004

Conventions Used in This Manual

Safety Markings

The following marking is used in this manual.



Improper handling or use can lead to injury to the user or damage to the instrument. This symbol appears on the instrument to indicate that the user must refer to the user's manual for special instructions. The same symbol appears in the corresponding place in the user's manual to identify those instructions. In the manual, the symbol is used in conjunction with the word "WARNING" or "CAUTION."

WARNING

Describes precautions that should be observed to prevent serious injury or death to the user.

CAUTION

Describes precautions that should be observed to prevent minor or moderate injury, or damage to the instrument.

Note

Provides important information for the proper operation of the instrument.

Notations Used on Pages Describing Operating Procedures

On pages that describe the operating procedures in Chapter 1 through 2, the following notations are used to distinguish the procedures from their explanations.

Procedure

This subsection contains the operating procedure used to carry out the function described in the current chapter. All procedures are written with inexperienced users in mind; experienced users may not need to carry out all the steps.

Explanation

This section describes the setup items and the limitations regarding the procedures.

Notations Used in the Procedures

Panel Keys and Soft keys

Bold characters used in the procedural explanations indicate characters that are marked on the panel keys or the characters of the soft keys or menus displayed on the screen.

SHIFT + Panel Key

SHIFT+key means you will press the SHIFT key to turn ON the green indicator that is located above the SHIFT key and then press the panel key. The setup menu marked in purple above the panel key that you pressed appears on the screen.

Jog Shuttle &SELECT

Jog shuttle & SELECT indicates selecting or setting parameters and entering values using the jog shuttle, the SELECT key, and other keys. For details on the procedure, see section 3.1 or 3.2 in the *DL1720E/DL1740E/DL1740EL User's Manual (IM701730-01E)*.

Units

k	Denotes 1000.	Example: 100 kS/s
K	Denotes 1024.	Example: 459 KB (file data size)

Contents

1

Conventions Used in This Manual	ii
---------------------------------------	----

2

Chapter 1 I²C Bus Signal Analysis Function

1.1	Overview of the I ² C Bus Signal Analysis Function	1-1
1.2	Flow of Operation	1-2
1.3	Connecting the Probe	1-3
1.4	Setting the I ² C Bus Signal Acquisition Conditions	1-4
	• Setting the Trigger Conditions of the I ² C Bus Signal	1-4
	• Setting the Start Condition or Stop Condition	1-6
	• Setting the Combination Trigger	1-7
	• Setting the Trigger Level, Trigger Coupling, Etc.	1-9
	• Setting the Trigger Mode	1-9
	• Setting the Record Length	1-9
	• Starting/Stopping the I ² C Bus Signal Acquisition	1-9
	• Examples of Setting the Trigger Conditions of the I ² C Bus Signal	1-15
1.5	Analyzing/Searching Data	1-25
1.6	Saving the Data of the Detailed Analysis List	1-35
1.7	Error Messages	1-37
1.8	Communication Commands	1-38

3

Chapter 2 SPI Bus Signal Analysis Function

2.1	Overview of the SPI Bus Signal Analysis Function	2-1
2.2	Flow of Operation	2-3
2.3	Connecting the Probe	2-4
2.4	Setting SPI Bus Signal Acquisition Conditions	2-5
	• Setting the Trigger Conditions of the SPI Bus Signal	2-5
	• Setting the Trigger Level, Trigger Coupling, Etc.	2-8
	• Setting the Trigger Mode	2-8
	• Setting the Record Length	2-8
	• Starting/Stopping the SPI Bus Signal Acquisition	2-8
	• Examples of SPI Bus Signal Trigger Conditions	2-12
2.5	Analyzing/Searching Data	2-19
2.6	Saving the Data of the Detailed Analysis List	2-32
2.7	Error Messages	2-34
2.8	Communication Commands	2-35

Chapter 3 Specification

3.1	I ² C Bus Signal Analysis Function	3-1
3.2	SPI Bus Signal Analysis Function	3-3

Index

Index

1.1 Overview of the I²C Bus Signal Analysis Function

About the I²C Bus Signal Analysis Function

I²C Bus is an abbreviation for Integrated Circuit Bus. It is a bidirectional bus for connecting ICs. By using this function, you will be able to analyze data while displaying the I²C-bus signal waveform. The I²C Bus Signal Analysis Function consists of the following three main functions.

Trigger Function <See page 1-4 for the operating procedure>

Various trigger conditions for the I²C Bus signal can be set up such as when a start condition is detected, when an Acknowledge bit is not detected, when the specified address (7 bits + R/W) pattern is met, or when the data pattern is met or not met (Non-Ack trigger or address & data trigger).

Triggers can also be activated by combining the I²C Bus signal (SCL signal (CH1)/SDA signal (CH2) and the CH3 to CH4 signal (combination trigger).

Address & Data Trigger Example

- When Activating a Trigger on the Start Condition or Address Pattern/Data Pattern

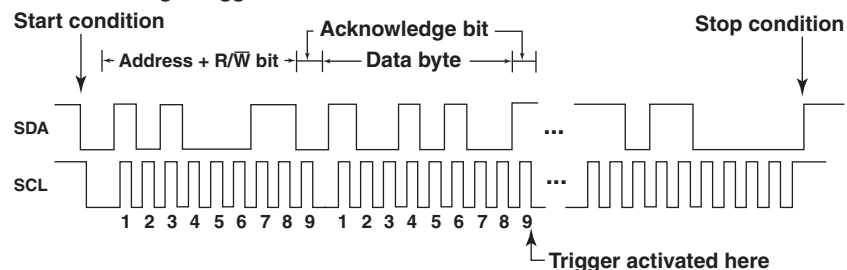

Non-ACK Trigger Example

- When Activating a Trigger When the Acknowledge Bit Is Not Present (When the SDA Signal is high)

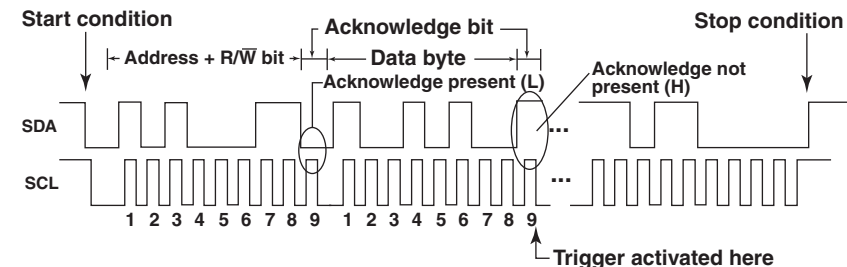

Analysis Function <See page 1-25 for the operating procedure>

Analyzes the I²C Bus signal that was acquired using the trigger function and lists the analysis data (hexadecimal notation) at the byte level and the status of the Acknowledge bit. When you select any analysis data on this analysis result list, the I²C Bus signal waveform corresponding to the analysis data is automatically displayed. You can view the details of the analysis result such as the position of the start condition/stop condition or the time from the analysis reference point on the detailed analysis list. You can save the detailed analysis list on a storage medium in ASCII format.

In addition, you can analyze the data by switching between two sets of I²C Bus signals (CH1: SCL and CH2: SDA or CH3: SCL and CH4: SDA).

Search Function <See page 1-28 for the operating procedure>

After analyzing the I²C Bus signal that was acquired using the trigger function, this function searches in the forward or reverse direction for data that matches a specified address pattern, data pattern, or Acknowledge bit condition, and displays the matched data expanded on the ZOOM display. You can specify the address pattern or data pattern using binary or hexadecimal values. You can also search indefinite data.

1.2 Flow of Operation

The figure below provides an overview of the flow of operations when using the I²C Bus Signal Analysis Function. For details about specific items, see the referenced pages in this manual or the respective sections in the *DL1720E/DL1740E/DL1740EL User's Manual (IM701730-01E)*.

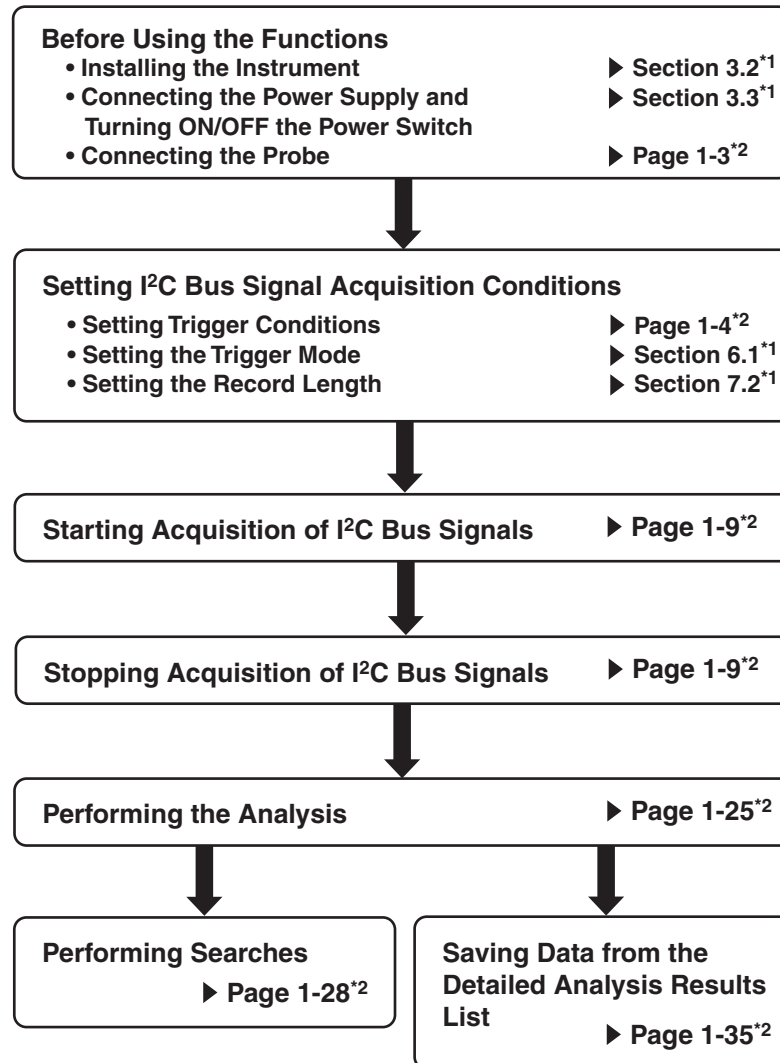

*1. Indicates reference sections from the DL1720E/DL1740E/DL1740EL user's manual (IM701730-01E).

*2. Indicates reference pages from this manual.

1.3 Connecting the Probe

Input Terminals

Connect the probe (or other input cables such as the BNC cable) to any of the input terminals located on the lower section of the front panel. The input impedance is $1\text{ M}\Omega \pm 1.0\%$ and approximately 20 pF or $50\ \Omega \pm 1.0\%$.



CAUTION

- The maximum input voltage for 1-M Ω input is 400 V (DC + AC_{peak}) or 282 V_{rms} when the frequency is 1 kHz or less. Applying a voltage exceeding either of these voltages can damage the input section. If the frequency is above 1 kHz, the input section may be damaged even when the voltage is below the values specified above.
- The maximum input voltage for 50- Ω input is 5 V_{rms} or 10 V_{peak}. Applying a voltage exceeding either of these voltages can damage the input section.

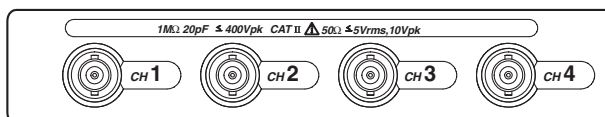

Precautions to Be Taken When Connecting a Probe

- When activating triggers on the I²C Bus signal, apply the SCL (serial clock) signal and SDA (serial data) signal to the CH1 and CH2 input terminals, respectively.
- When connecting a probe to the instrument for the first time, perform phase correction of the probe as described in section 3.5, "Compensating the Probe (Phase Correction)" in the *DL1720E/DL1740E/DL1740EL User's Manual (IM701730-01E)*. Failure to do so may result in unstable gain across different frequencies, thereby preventing correct measurement. Calibration must be performed for each channel that is to be connected.
- Note that if the object being measured is directly connected to the instrument without using a probe, correct measurements may not be possible due to loading effects.

Note

Data analysis and data search can be performed on I²C Bus signals applied to CH3 and CH4. For details, see section 1.5, "Analyzing/Searching Data."

1.4 Setting the I²C Bus Signal Acquisition Conditions

I²C Bus signal is acquired using a certain condition* of the I²C Bus signal as a trigger condition.

* When a start condition is detected, when an Acknowledge bit is not detected, when the specified address (7 bits + R/W) pattern is met, when the data pattern is met or not met, etc.

Procedure

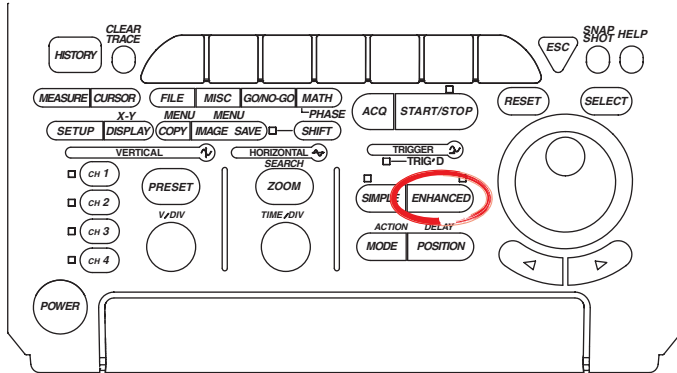

- To exit the menu during operation, press **ESC** located above the soft keys.
- In the procedural explanation below, the term *jog shuttle* & **SELECT** refers to the operation of selecting/setting items and entering values using the *jog shuttle* and **SELECT** and **RESET** keys. For details on this operation, see sections 4.1 or 4.2 in the DL1720E/DL1740E/DL1740EL User's Manual.
- For a description of the operation using a USB keyboard or a USB mouse, see section 4.3 in the DL1720E/DL1740E/DL1740EL User's Manual.

1. Press **ENHANCED**. The ENHANCED menu appears.
2. Press the **Type** soft key. The trigger type selection menu appears.

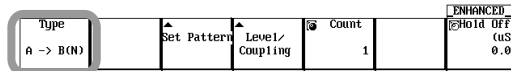

3. Press the **I²C Bus** soft key.

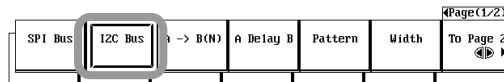

Setting the Trigger Conditions of the I²C Bus Signal

4. Press the **I²C Setup** soft key. The I²C Setup dialog box opens.

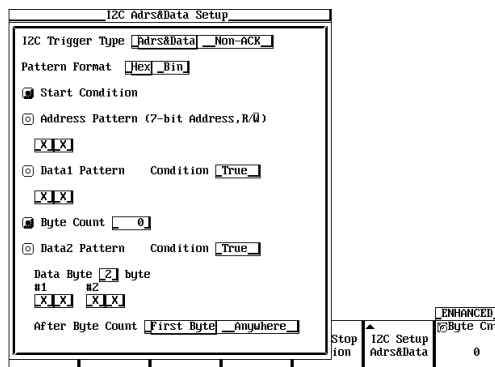
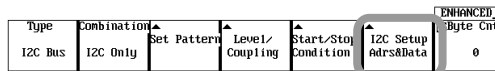

To activate triggers on the start condition or address pattern/data pattern, proceed to step 5 below. To activate triggers when an Acknowledge bit is not detected (Non-Ack trigger), proceed to step 16 on the next page.

• **Activating Triggers on the Start Condition or Address Pattern/Data Pattern**

5. Use **jog shuttle & SELECT** to select Adrs&Data (I²C Trigger Type box).

Setting the Notation System of the Address Pattern or Data Pattern

6. Use **jog shuttle & SELECT** to set the notation system used to set the pattern to Hex or Bin (Pattern Format box). The format used to set the Address Pattern box, Data1 Pattern box, and Data2 Pattern box are set to the specified notation system.

Selecting the Items Used as Trigger Conditions

7. Use **job shuttle & SELECT** to select whether Start Condition, Address Pattern, Data1 Pattern, Byte Count, and Data2 Pattern are used as trigger conditions. If you select Address Patten, proceed to step 8. If you select Data1 Pattern, proceed to step 9. If you wish to set Byte Count, proceed to step 11. If you select Data2 Pattern, proceed to step 12.

- Highlighting of the mark to the left of each item indicates that it is used as a trigger condition.
- Start Condition and Byte Count items are always used as trigger conditions (the mark to the left is always highlighted).
- If you do not wish to use byte count as a trigger condition, set Byte Count to 0 (see step 11).

When Using Address Pattern as a Trigger Condition

8. Use **jog shuttle & SELECT** to set the address pattern in hexadecimal or binary (Address Pattern box). When determination is not to be performed, select X. When using binary (BIN) notation, set the LSB using “R” (Read), “W” (Write), and “X.”

When Using Data1 Pattern as a Trigger Condition

9. Use **jog shuttle & SELECT** to set the determination pattern of Data1 in hexadecimal or binary (Data1 Pattern box). When determination is not to be performed, select X.

10. Use **jog shuttle & SELECT** to set the Condition of the Data1 Pattern to True or False (Condition box).

When Setting the Byte Count

11. Use **jog shuttle & SELECT** to set the byte count in the range of 0 to 9999 bytes (Byte Count box).

- If you do not wish to use byte count as a trigger condition, set the value to 0.
- You can also set the byte count using the soft key that appears at the bottom of the ENHANCED menu (a menu that appears when you carry out steps 1 to 3 on the previous page). This byte count soft key menu appears only when I²C Trigger Type is set to Adrs&Data.

The screenshot shows the 'I2C Adrs&Data Setup' menu. Annotations include:

- Select Adrs&Data:** Points to the 'I2C Trigger Type' dropdown menu.
- Select the setting format of the address pattern and data pattern:** Points to the 'Pattern Format' dropdown menu.
- The condition of activating the trigger when a start condition is detected is always enabled:** Points to the 'Start Condition' checkbox.
- To activate triggers on the address pattern, select this check box and set the pattern:** Points to the 'Address Pattern' checkbox and its input field.
- To activate triggers on the Data1 pattern, select this check box and set the pattern and conditions:** Points to the 'Data1 Pattern' checkbox and its 'Condition' dropdown.
- Set the byte count in the range of 0 to 9999:** Points to the 'Byte Count' input field.
- When Pattern Format is set to Bin:** Points to the expanded 'Address Pattern' input field showing '0001 100R'.
- Set the LSB using R (Read), W (Write), or X.** Points to the 'R' character in the expanded address pattern.

1.4 Setting the I²C Bus Signal Acquisition Conditions

When Using Data2 Pattern as a Trigger Condition

12. Use **jog shuttle & SELECT** to set the data length of the determination pattern of Data2 that is to be specified to 1 or 2 bytes (Data Byte box). The number of bytes displayed in the Data2 Pattern box is set to the number of bytes that matches the selected result.
13. Use **jog shuttle & SELECT** to set the determination pattern of Data2 in hexadecimal or binary (Data2 Pattern box). When determination is not to be performed, select X.
14. Use **jog shuttle & SELECT** to set the Condition of the Data2 Pattern to True or False (Condition box).
15. Use **jog shuttle & SELECT** to select whether to compare the Data2 Pattern to the pattern immediately after the byte count (First Byte) or continue to compare until the stop condition is detected (Anywhere) (After Byte Count box).

To activate triggers on the Data2 pattern, select this check box and set the pattern and conditions. Set the byte count to 1 byte or 2 bytes.

Select whether to compare the Data2 pattern to the pattern immediately after the byte count or continue comparing until the stop condition is detected.

Proceed to step 17.

- **When Activating a Trigger When an Acknowledge Bit Is Not Detected (Non-Ack Trigger)**

16. Use **jog shuttle & SELECT** to select Non-ACK (I²C Trigger Type box).

Select Non-ACK.

17. Press **ESC**. The Detail dialog box closes.

Setting the Start Condition or Stop Condition

18. Press the **Start/Stop Condition** soft key. The Start/Stop Condition dialog box opens.

Type	Combination	Set Pattern	Level/ Coupling	Start/Stop Condition	I2C Setup Adrs&Data	ENHANCED Byte Cnt
I2C Bus	I2C Only					0

- **Setting Whether to Ignore Restart Conditions**

19. Use **jog shuttle & SELECT** to select whether to ignore restart conditions (Ignore the Restart Condition box).

- **Setting Whether to Ignore Start/Stop Conditions That Do Not Conform to the Protocol**

20. Use **jog shuttle & SELECT** to select whether to ignore start/stop conditions that do not conform to the protocol (Ignore Unexpected Start/Stop Condition box).

Select whether to ignore restart conditions.

Select whether to ignore start/stop conditions that do not conform to the protocol.

21. Press **ESC**. The Start/Stop Condition dialog box closes.

Setting the Combination Trigger

22. Press the **Combination** soft key. The Combination menu appears.

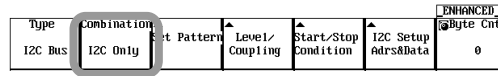

23. Press the **I²C Only**, **I²C on Pattern**, or **I²C -> Pattern** soft key.

Select I²C Only to activate a trigger only on the trigger conditions of the I²C Bus signal. Select I²C on Pattern to activate a trigger when the trigger conditions of the I²C Bus signal are met while the trigger conditions of CH3 to CH4 are met. Select I²C -> Pattern to activate a trigger when the trigger conditions of CH3 to CH4 are met after the trigger conditions of the I²C Bus signal are met.

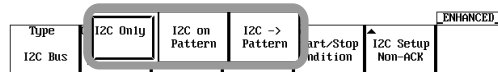

• **When I²C Only Is Selected**

24. Press the **Set Pattern** soft key. The Set Pattern dialog box displays the assignment conditions of the I²C Bus signal of CH1 and CH2.

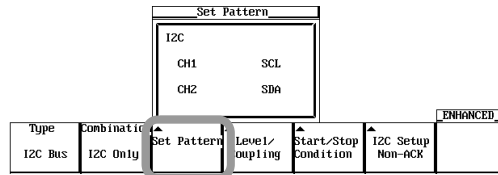

25. Press **ESC**. The Set Pattern dialog box closes. Proceed to step 29.

• **When I²C On Pattern Is Selected**

24. Press the **Set Pattern** soft key. The Set Pattern dialog box displays the assignment conditions of the I²C Bus signal of CH1 and CH2 and the setup screen for the patterns of CH3 to CH4.

25. Use **jog shuttle & SELECT** to set the patterns of CH3 to CH4 using H (high), L (low), and X.

26. Use **jog shuttle & SELECT** to set the pattern condition to True or False (Condition box).

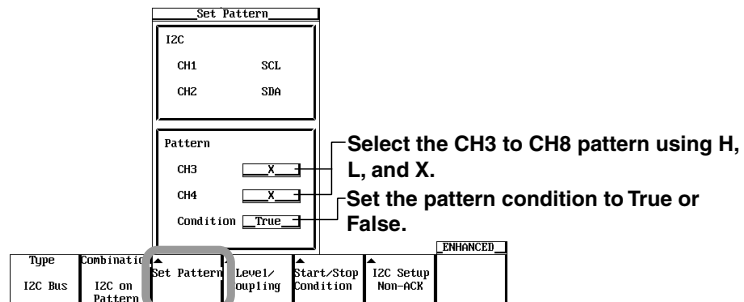

27. Press **ESC**. The Set Pattern dialog box closes. Proceed to step 29.

1.4 Setting the I²C Bus Signal Acquisition Conditions

- **When I²C -> Pattern Is Selected**

24. Press the **Set Pattern** soft key. The Set Pattern dialog box displays the assignment conditions of the I²C Bus signal of CH1 and CH2 and the setup screen for the patterns of CH3 to CH4.

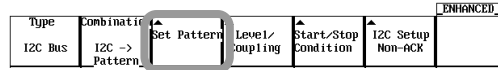

25. Use **jog shuttle & SELECT** to set the clock channel to None or any of the channels from CH3 to CH4 (Clock CH box).
26. Use **jog shuttle & SELECT** to set the patterns of CH3 to CH4 using H (high), L (low), and X. For the channel set as the clock channel in step 25, set the slope to \uparrow (rising edge) or \downarrow (falling edge).
27. If you set the clock channel to None in step 25, use **jog shuttle & SELECT** to set the pattern condition to Enter or Exit (Condition box).

When Clock CH is set to None

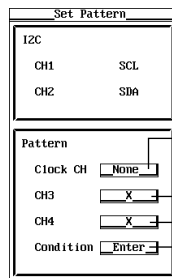

- Select the clock channel from None.
- Select the CH3 to CH4 pattern* using H, L, and X.
- Set the pattern condition to Enter or Exit.

When Clock CH is set to any channel from CH3 to CH4

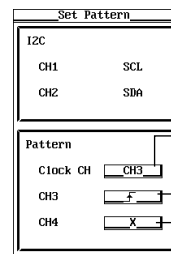

- Select the clock channel from CH3 to CH4.
- Select the CH3 to CH4 pattern* using H, L, and X.

* Set the slope of the channel selected for the clock channel to \uparrow or \downarrow .

28. Press **ESC**. The Set Pattern dialog box closes. Proceed to step 29.

Note

If you set Combination to I²C -> Pattern and set the patterns of CH3 to CH4 to all Xs, triggers will not be activated. If the clock channel is set to any of the channels from CH3 to CH4, the pattern conditions of other channels are always set to true.

Setting the Trigger Level, Trigger Coupling, Etc.

29. Press the **Level/Coupling** soft key. The Level/Coupling dialog box opens.
30. Set the trigger level, trigger hysteresis, trigger coupling, and HF rejection of each channel. For the setup procedure, see steps 9 to 13 on page 6-15 in the *DL1720E/DL1740E/DL1740EL User's Manual (IM701730-01E)*.

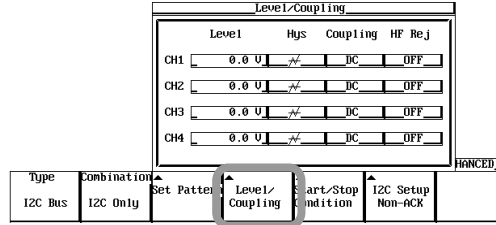

31. Press **ESC**. The Level/Coupling dialog box closes.

Setting the Trigger Mode

32. Set the trigger mode according to the procedures given in section 6.1, "Setting the Trigger Mode" in the *DL1720E/DL1740E/DL1740EL User's Manual (IM701730-01E)*.

Setting the Record Length

33. Set the record length according to the procedures given in section 7.2, "Setting the Record Length" in the *DL1720E/DL1740E/DL1740EL User's Manual (IM701730-01E)*.

Starting/Stopping the I²C Bus Signal Acquisition

34. Press **START/STOP** to start the I²C Bus signal acquisition. Triggers are activated on the specified trigger conditions.
To proceed to the analysis, press **START/STOP** to stop the I²C Bus signal acquisition.

Explanation

Setting the Trigger Conditions of the I²C Bus Signal: I²C Setup

You can set the following conditions.

- **Trigger Type of the I²C Bus Signal: I²C Trigger Type**

Select either of the following trigger types.

Adrs&Data

When activating a trigger on the start condition or address pattern/data pattern (address & data trigger)

Non-ACK

When activating a trigger when an Acknowledge bit is not detected (Non-Ack trigger)

Address & Data Trigger

- **When activating a trigger when the start condition is detected**

When the start condition is detected, a trigger is activated on the first rising edge of the SCL signal.

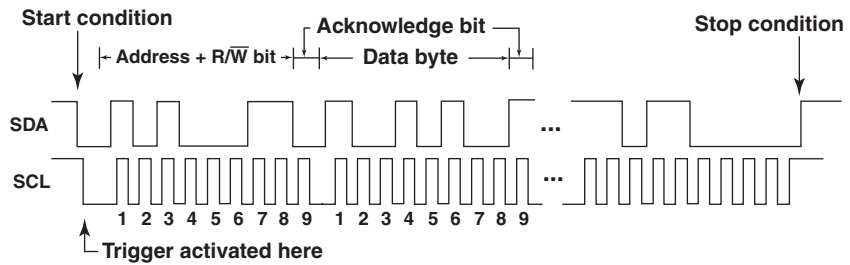

- **When Activating a Trigger on the Address Pattern/Data Pattern**

When the data matches the specified address pattern or data pattern, a trigger is activated on the 9th falling edge of the SCL (clock) signal.

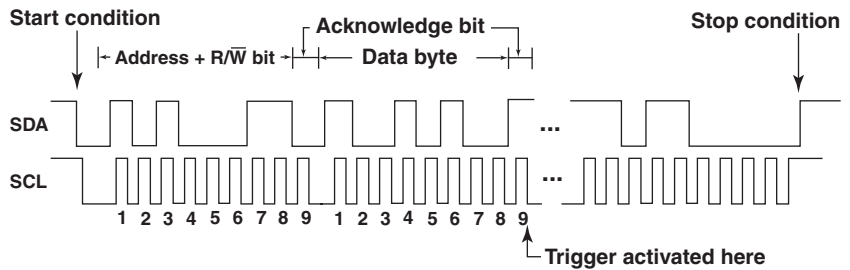

Non-ACK Trigger

- **When Activating a Trigger When the Acknowledge Bit Is Not Present (When the SDA Signal is high)**

When an Acknowledge bit is not detected, a trigger is activated on the 9th falling edge of the SCL (clock) signal.

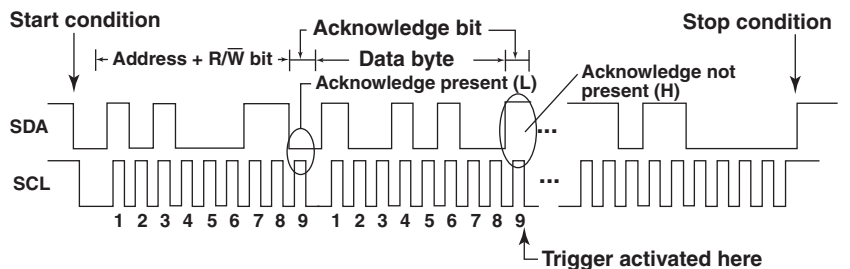

Note

The Acknowledge bit of the start byte and Hs mode master code is not applicable.

If you set the trigger type to Adrs&Data, you can set the following items.

Pattern Format

Select the format of the address pattern and Data 1 Pattern/Data2 Pattern.

Hex	Hexadecimal
Bin	Binary

Address Pattern

Set the 7-bit address and R (read)/ \overline{W} (write). A trigger is activated when the specified address pattern and R/\overline{W} match.

Data1 Pattern

Set the 8-bit data pattern. The data that is compared is the single byte immediately after the address.

Select the pattern condition from below.

True	A trigger is activated when Data1 Pattern is met.
False	A trigger is activated when Data1 Pattern is not met.

Byte Count

Set the byte count in the range of 0 to 9999 bytes. If you do not wish to use byte count as a trigger condition, set the value to 0. You can also set the byte count from the ENHANCED menu.

Data2 Pattern

Set the 1-byte (8-bit) or 2-byte (16-bit) data. You can set the number of bytes in the Data Byte box.

Select the pattern condition from below.

True	A trigger is activated when Data2 Pattern is met.
False	A trigger is activated when Data2 Pattern is not met.

In addition, select the location of the byte data to be compared against Data2 Pattern.

First Byte	Compares the byte data immediately after the byte count.
Anywhere	Compares from the byte data immediately after the byte count until the condition is met.

Note

For address pattern and Data1 Pattern/Data2 Pattern, if there is at least one "X" bit in a group of four bits in the binary display, the corresponding hexadecimal display will show an "\$."

1.4 Setting the I²C Bus Signal Acquisition Conditions

Setting the Start/Stop Condition

You can set the following conditions.

- **Setting Whether to Ignore Restart Conditions**

You can select whether to ignore the Restart condition that occurs after starting the trigger detection upon detecting the Start condition.

Yes	Ignores the restart condition and continues with the trigger detection.
No	Restarts the trigger detection when a restart condition is detected.

- **Setting Whether to Ignore Start/Stop Conditions That Do Not Conform to the Protocol**

You can select whether to ignore the start or stop condition that occurs in the middle of the address or data bit while detecting the trigger.

Yes	Ignores the start/stop condition and continues with the trigger detection.
No	Restarts or stops the trigger detection when a start/stop condition is detected.

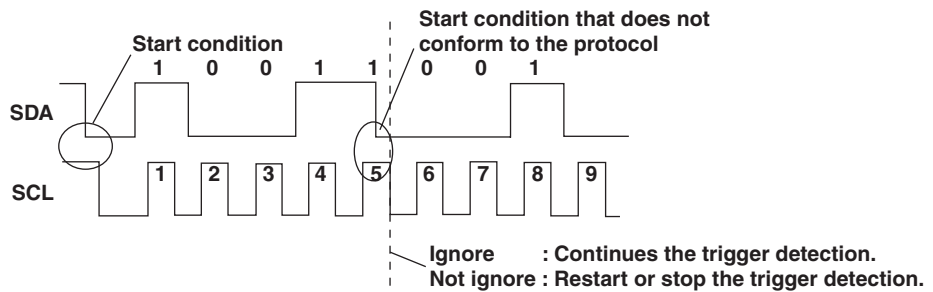

Setting the Combination Trigger

A trigger can be activated on the combination of the trigger conditions of the I²C Bus signal and the trigger conditions of CH3 to CH4. You can select from the following three types.

- **I²C Only**

Activates a trigger only on the SCL/SDA signal (trigger conditions of the I²C Bus).

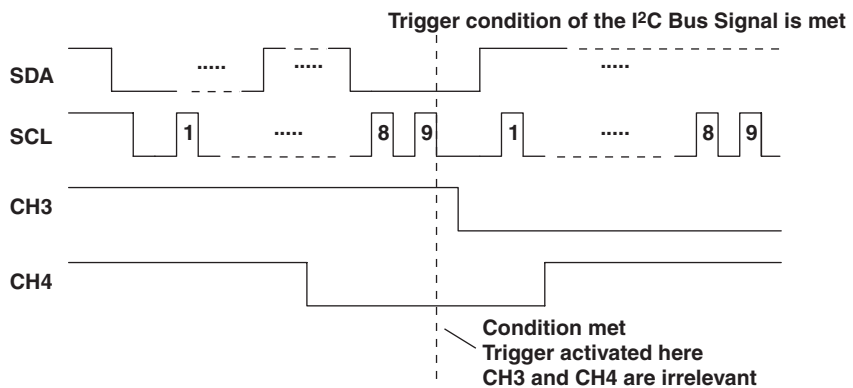

• **I²C on Pattern**

Activates a trigger on the SCL/SDA signal and the patterns of CH3 to CH4. A trigger is activated only when the trigger conditions of the I²C Bus are met while the trigger conditions of CH3 to CH4 are met.

CH3 = L, CH4 = H, Condition = True

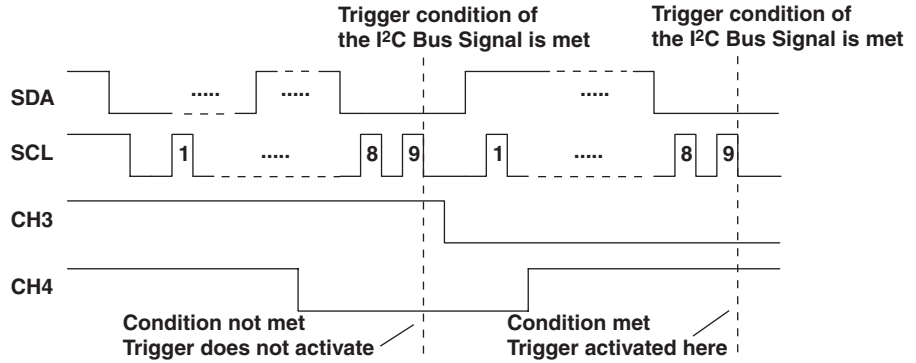

• **Patterns of CH3 to CH4**

H	The trigger source level is above the preset trigger level.
L	The trigger source level is below the preset trigger level.
X	Not used as a trigger source.

• **Pattern Condition**

True	A trigger is activated when the specified pattern of CH3 to CH4 is met.
False	A trigger is activated when the specified pattern of CH3 to CH4 is no longer met.

• **I²C -> Pattern**

Activates a trigger on the SCL/SDA signal and the preset patterns of CH3 to CH4. The SCL/SDA trigger met condition is held until the trigger conditions of CH3 to CH4 are met.

CH3 = L, CH4 = H, Condition = Enter

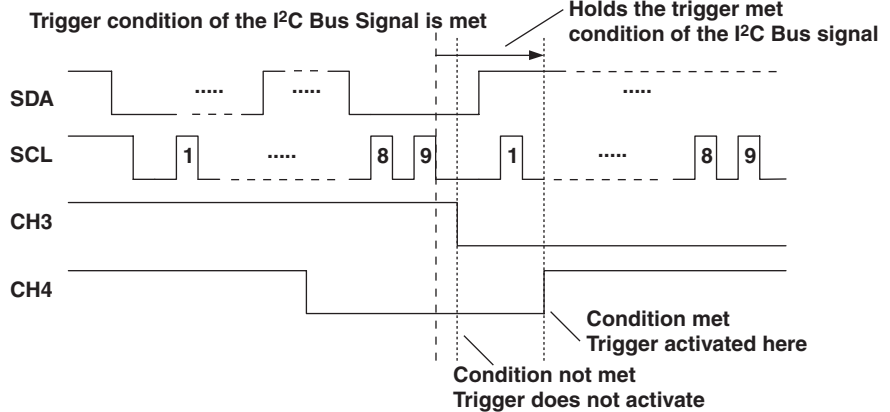

Clock Channel

You can set a clock channel from CH3 to CH4. If you do not wish to set a clock channel, select None.

1.4 Setting the I²C Bus Signal Acquisition Conditions

Patterns of CH3 to CH4

- | | |
|---|---|
| H | The trigger source level is above the preset trigger level. |
| L | The trigger source level is below the preset trigger level. |
| X | Not used as a trigger source. |

For the channel set as the clock channel, set the slope to \uparrow (rising edge) or \downarrow (falling edge), not the pattern.

Pattern Condition

You can set the pattern condition only when a clock channel is not specified. Select from the following:

- | | |
|-------|---|
| Enter | A trigger is activated when the specified pattern of CH3 to CH4 is met. |
| Exit | A trigger is activated when the specified pattern of CH3 to CH4 is no longer met. |

If you set the clock channel to any of the channels from CH3 to CH4, the pattern condition is set to true.

Setting the Trigger Level, Trigger Coupling, Etc.: Level/Coupling

Set the trigger level, hysteresis, trigger coupling, and HF rejection of each channel.

For details on the trigger level, hysteresis, trigger coupling, and HF rejection, see page 6-17 in section 6.8, "Setting the A->B(N) Trigger (ENHANCED)" in the *DL1720E/DL1740E/DL1740EL User's Manual (IM701730-01E)*.

Setting the Trigger Mode

Set the conditions for updating the displayed waveforms as a trigger mode. There are five trigger modes: auto mode, auto level mode, normal mode, single mode, and single (N) mode.

For details on the trigger modes, see section 6.1, "Selecting the Trigger Mode" in the *DL1720E/DL1740E/DL1740EL User's Manual (IM701730-01E)*.

Setting the Record Length

The record length sets the amount of data to be written into the acquisition memory. The selectable maximum record length varies depending on the model.

DL1740E	1 k, 10 k, 50 k, 100 k, 250 k, 500 k, 1 M (, 2 M)*
DL1740EL	1 k, 10 k, 50 k, 100 k, 250 k, 500 k, 1 M, 2 M, 4 M (, 8 M)*

* The value inside the parentheses is selectable only when interleave mode is ON.

For details on the record length, see section 7.2, "Setting the Record Length" in the *DL1720E/DL1740E/DL1740EL User's Manual (IM701730-01E)*. For details on interleave mode, see section 7.3, "Using Interleave Mode."

Starting/Stopping the Acquisition of the I²C Bus Signal

When you start the acquisition of the I²C Bus signal, triggers are activated on the specified trigger conditions.

To proceed to the analysis, you stop the acquisition of the I²C Bus signal.

Examples of Setting the Trigger Conditions of the I²C Bus Signal

This section will indicate the data sequence in bytes (hexadecimal notation) and indicate the position where the trigger will occur. The symbols used in the figures are as follows:

- S: Start condition
- Sr: Restart condition
- P: Stop condition
- Shaded area: Byte pattern to be compared

Non-ACK Trigger

A trigger is activated when the Acknowledge bit is not present (when the SDA signal is set to "H").

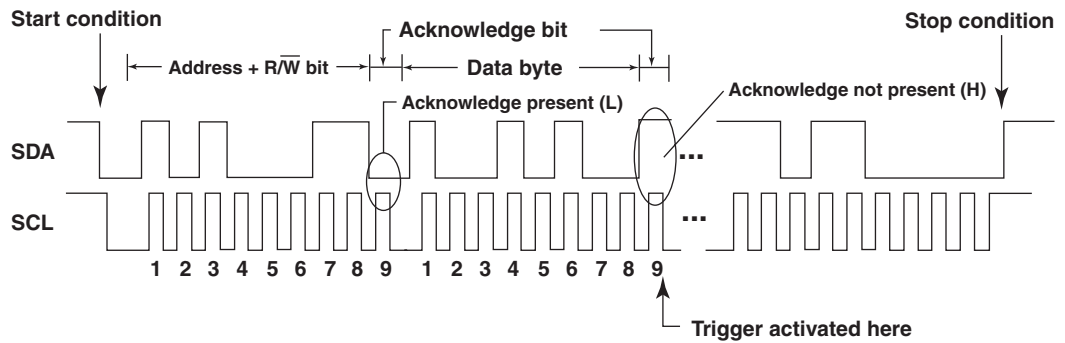

Note

The Non-Ack trigger does not apply to start byte and Hs mode master code.

Address & Data Trigger

- **Activate a Trigger Only on the Start Condition**

Trigger Condition

- Address Pattern: Not applicable
- Data 1 Pattern: Not applicable
- Condition: True
- Data 2 Pattern: Not applicable
- Condition: True
- Ignore the Restart Condition: No
- Ignore Unexpected Start/Stop Condition: No

<Byte Count=0>

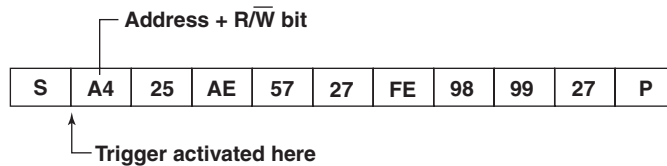

<Byte Count=3>

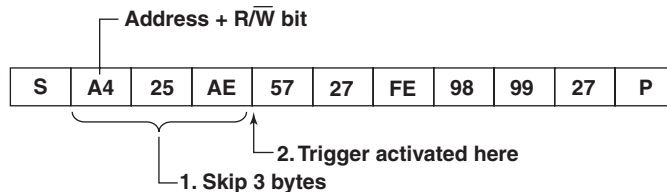

1.4 Setting the I²C Bus Signal Acquisition Conditions

- **Activate a Trigger Only on the Address Pattern**

Trigger Condition

Address Pattern: A4
 Data1 Pattern: Not applicable
 Condition: True
 Data2 Pattern: Not applicable
 Condition: True
 Ignore the Restart Condition: No
 Ignore Unexpected Start/Stop Condition: No

<Byte Count=0>

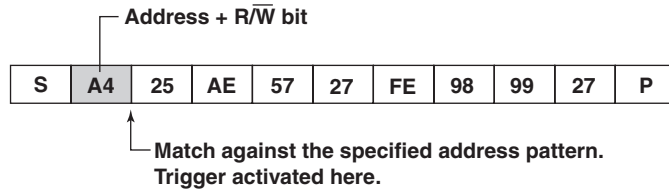

<Byte Count=3>

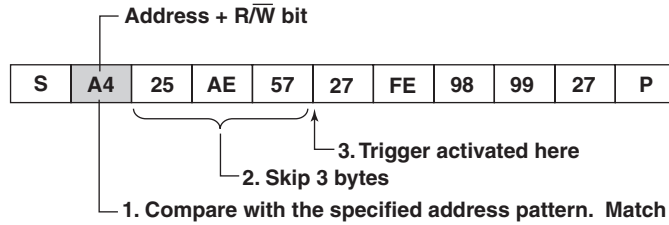

- **Activate a Trigger Only on the Data1 Pattern**

Trigger Condition

Address Pattern: Not applicable
 Data1 Pattern: 27
 Condition: True
 Data2 Pattern: Not applicable
 Condition: True
 Ignore the Restart Condition: No
 Ignore Unexpected Start/Stop Condition: No

<Byte Count=0>

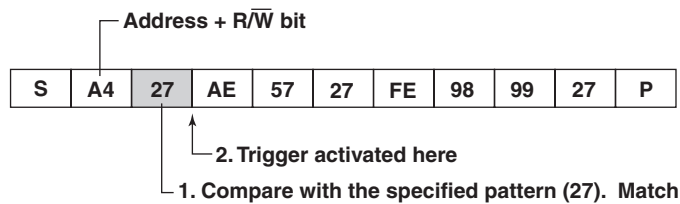

<Byte Count=3>

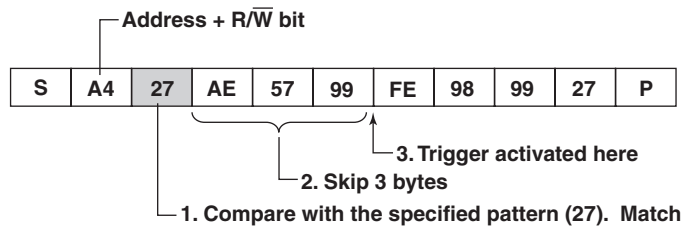

• **Activate a Trigger Only on the Data2 Pattern**

Trigger Condition

Address Pattern:	Not applicable
Data1 Pattern:	Not applicable
Condition:	True
Data2 Pattern:	99
Data Byte:	1
Condition:	True
Ignore the Restart Condition:	No
Ignore Unexpected Start/Stop Condition:	No

<Byte Count=0, Data2 After Byte Count=First Byte>

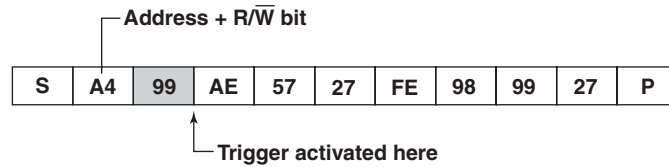

<Byte Count=0, Data2 After Byte Count=Anywhere>

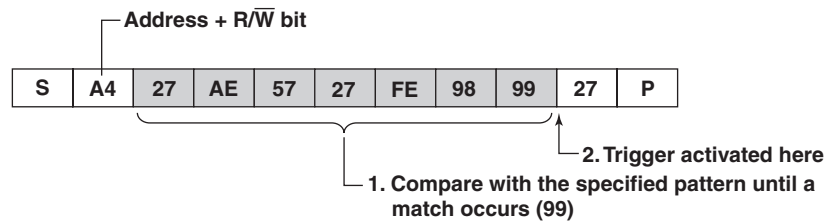

<Byte Count=3, Data2 After Byte Count=First Byte>

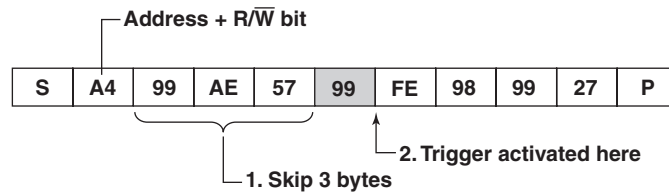

<Byte Count=3, Data2 After Byte Count=Anywhere>

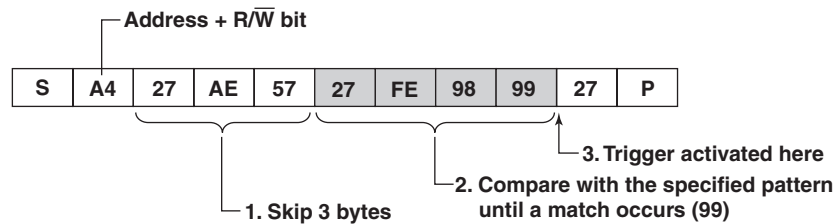

1.4 Setting the I²C Bus Signal Acquisition Conditions

Trigger Condition

Address Pattern:	Not applicable
Data1 Pattern:	Not applicable
Condition:	True
Data2 Pattern:	99 27
Data Byte:	2
Condition:	True
Ignore the Restart Condition:	No
Ignore Unexpected Start/Stop Condition:	No

<Byte Count=0, Data2 After Byte Count=First Byte>

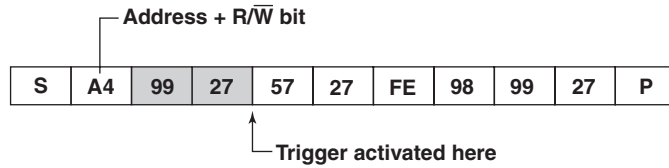

<Byte Count=0, Data2 After Byte Count=Anywhere>

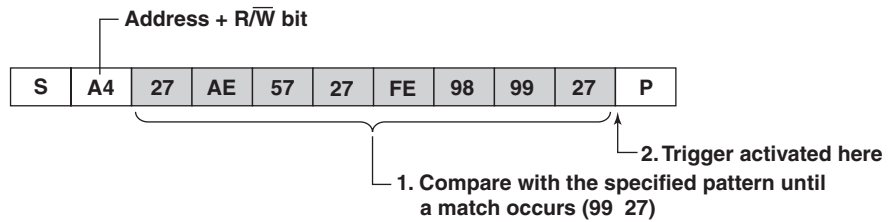

<Byte Count=3, Data2 After Byte Count=First Byte>

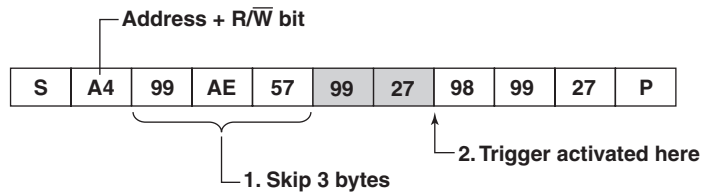

<Byte Count=3, Data2 After Byte Count=Anywhere>

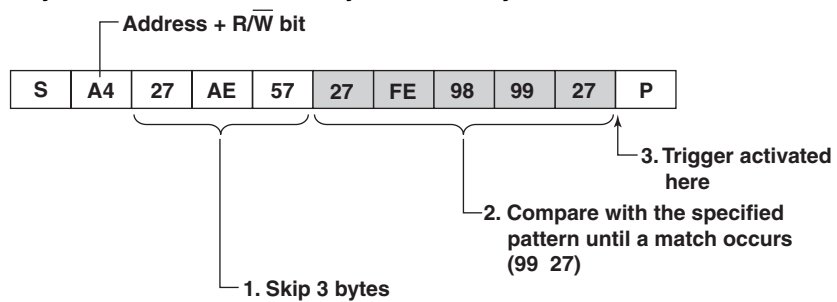

• **Combination of Address Pattern, Data1 Pattern, and Byte Count Trigger Condition**

Address Pattern:	A4
Data1 Pattern:	27
Condition:	True
Data2 Pattern:	Not applicable
Condition:	True
Ignore the Restart Condition:	No
Ignore Unexpected Start/Stop Condition:	No
Byte Count:	3

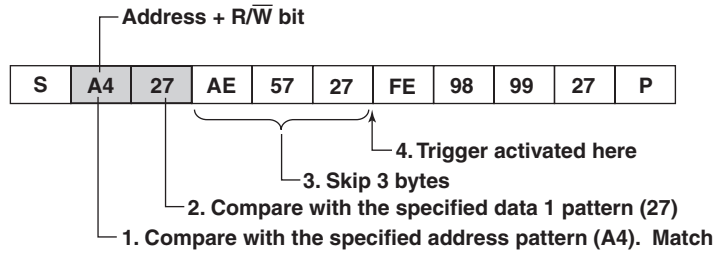

• **Combination of Address Pattern, Data2 Pattern, and Byte Count Trigger Condition**

Address Pattern:	A4
Data1 Pattern:	Not applicable
Condition:	True
Data2 Pattern:	99
Data Byte:	1
(Data Byte: compare 2 bytes when set to 2 bytes)	
Condition:	True
Ignore the Restart Condition:	No
Ignore Unexpected Start/Stop Condition:	No
Byte Count:	3

<After Byte Count=First Byte>

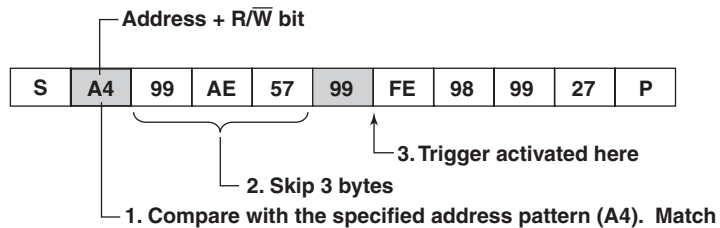

<After Byte Count=Anywhere>

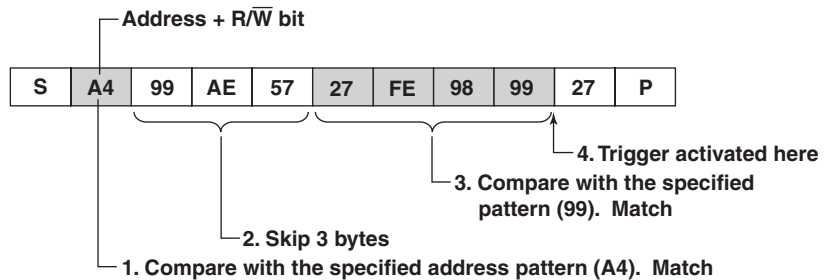

1.4 Setting the I²C Bus Signal Acquisition Conditions

- **Combination of Address Pattern, Data1 Pattern, Data2 Pattern, and Byte Count Trigger**

Trigger Condition

Address Pattern: A4
 Data1 Pattern: 27
 Condition: True
 Data2 Pattern: 99
 Data Byte: 1
 (Date Byte: compare 2 bytes when set to 2 bytes)
 Condition: True
 Ignore the Restart Condition: No
 Ignore Unexpected Start/Stop Condition: No
 Byte Count: 3

<After Byte Count=First Byte>

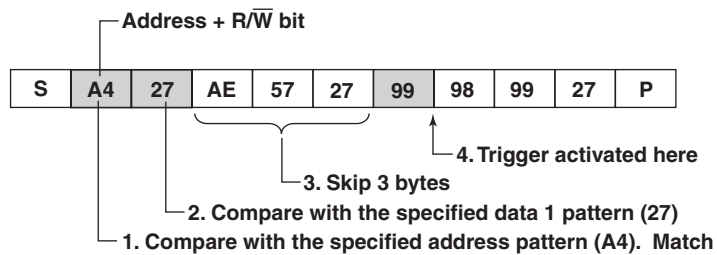

<After Byte Count=Anywhere>

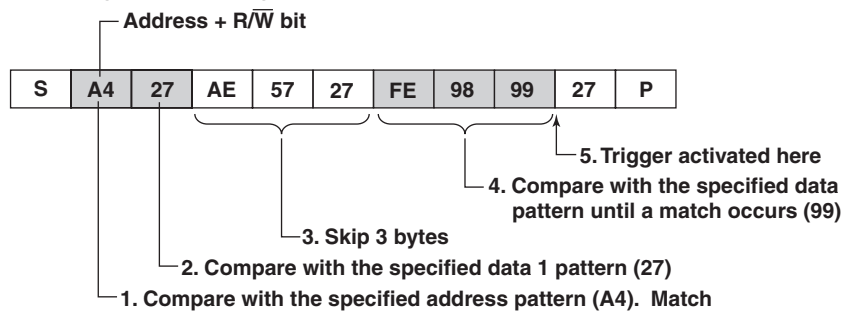

• Ignore/Not Ignore the Restart Condition

Trigger Condition

Address Pattern: F4
 Data1 Pattern: A2
 Coditon: True
 Data2 Pattern: F5
 Data Byte: 1
 Condition: True
 After Byte Count: Anywhere
 Ignore Unexpected Start/Stop Condition: No

<When Ignore the Restart Condition=Yes>

S	F4	A2	Sr	F5	30	27	E4	24	99	55
---	----	----	----	----	----	----	----	----	----	----

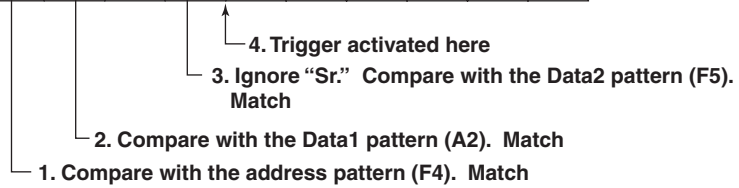

<When Ignore the Restart Condition=No>

S	F4	A2	Sr	F5	30	27	E4	24	99	55
---	----	----	----	----	----	----	----	----	----	----

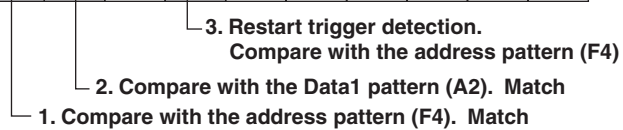

1.4 Setting the I²C Bus Signal Acquisition Conditions

- Ignore/Not Ignore Start/Stop Conditions That Do Not Conform to the Protocol

Trigger Condition

Address Pattern: 99
Data1 Pattern: Not applicable
Condition: True
Data2 Pattern: Not applicable
Condition: True
Ignore the Restart Condition: No

<When Ignore Unexpected Start/Stop Condition=Yes>

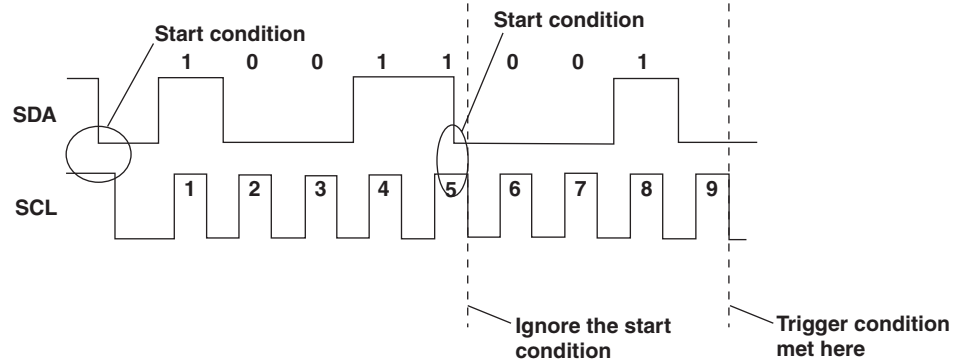

<When Ignore Unexpected Start/Stop Condition=No>

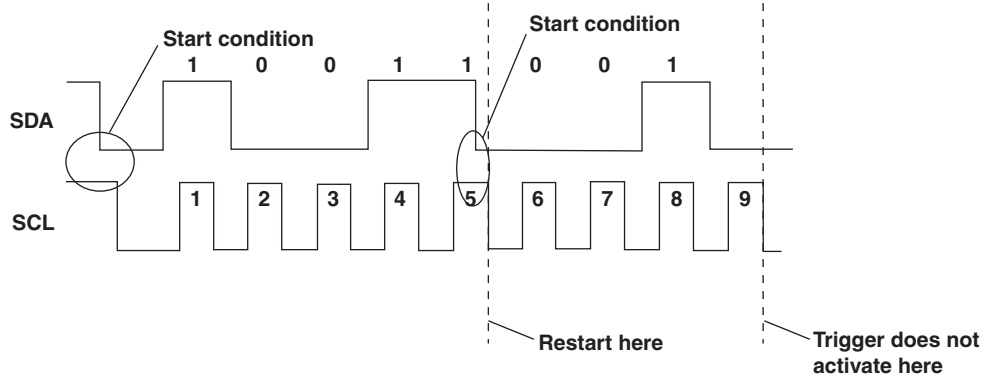

Combination Trigger

- I²C Only

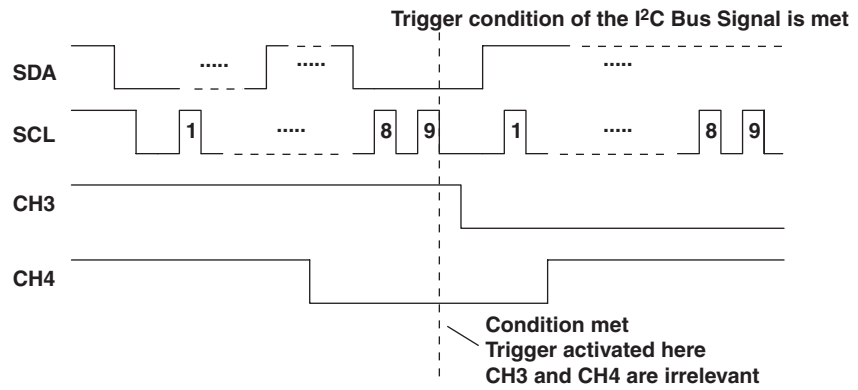

- I²C on Pattern

CH3 = L, CH4 = H, Condition = True

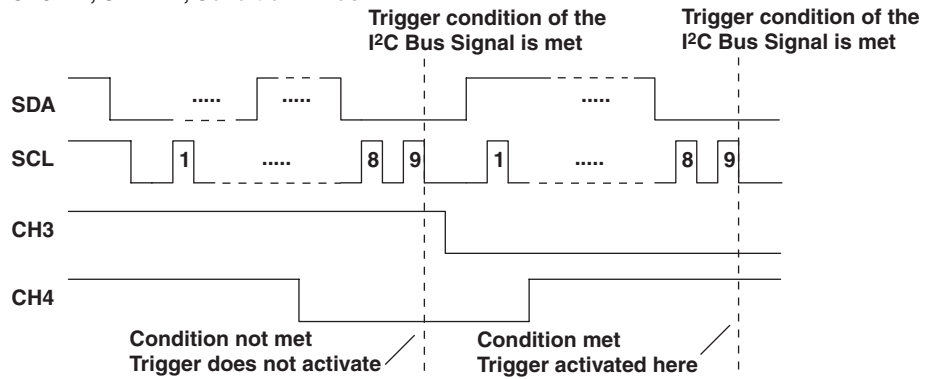

1.4 Setting the I²C Bus Signal Acquisition Conditions

- I²C -> Pattern

When the Clock Channel Is Set to "None"

CH3 = L, CH4 = H, Condition = Enter

Trigger condition of the I²C Bus Signal is met

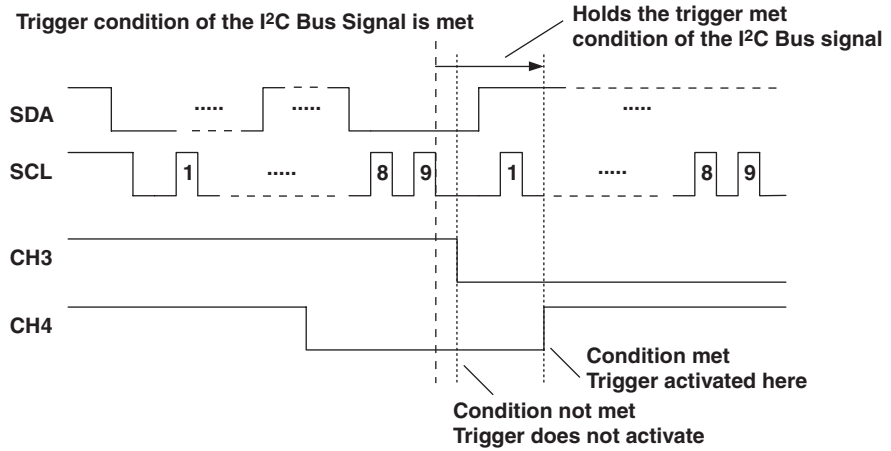

When the Clock Channel Is Set to "CH4"

CH3 = L, CH4 = \uparrow

Trigger condition of the I²C Bus Signal is met

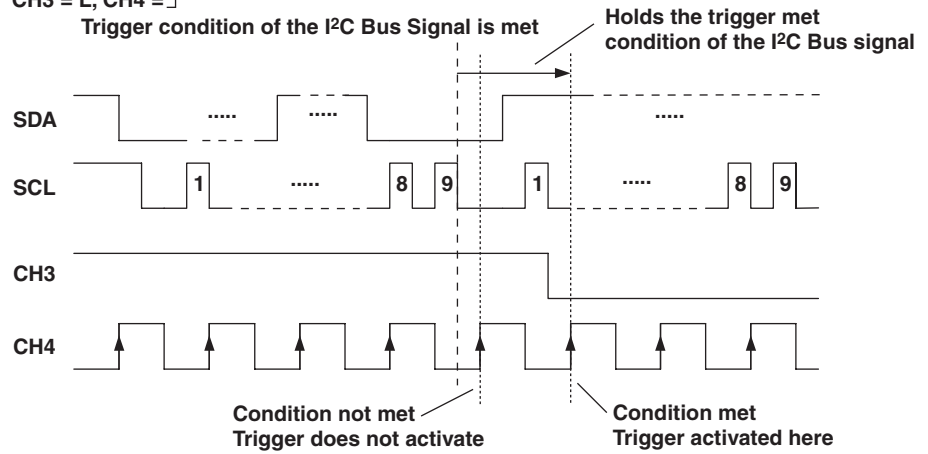

1.5 Analyzing/Searching Data

You can analyze the data of CH2 or CH4 by setting CH1 or CH3 to a clock channel. You can also search analysis data that matches a data pattern or an indefinite data condition. If analysis data that matches the specified condition is found, the zoom position moves to the corresponding section, and the waveform of the data that is found is displayed in the zoom waveform display frame.

Procedure

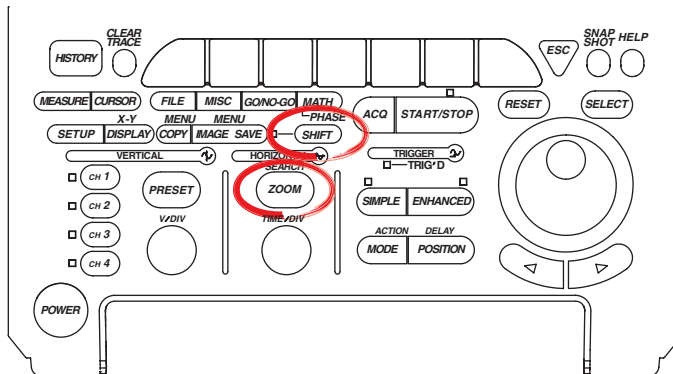

- To exit the menu during operation, press **ESC** located above the soft keys.
- In the procedural explanation below, the term *jog shuttle & SELECT* refers to the operation of selecting/setting items and entering values using the **jog shuttle** and **SELECT** and **RESET** keys. For details on this operation, see sections 4.1 or 4.2 in the DL1720E/DL1740E/DL1740EL User's Manual.
- For a description of the operation using a USB keyboard or a USB mouse, see section 4.3 in the DL1720E/DL1740E/DL1740EL User's Manual.

- Press **SHIFT+ZOOM (SEARCH)**. The SEARCH menu appears.
- Press the **Type** soft key. The Type menu appears.

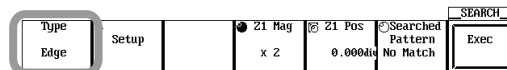

- Press the **I²C Bus** soft key.

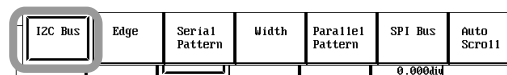

Setting the Analysis Conditions

- Press the **Analyze Setup** soft key. The Analyze Setup dialog box opens.

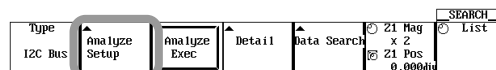

Setting the Clock Channel

- Use **jog shuttle & SELECT** to set the clock channel to CH1 or CH3 (Clock CH box).

Setting the Level

- Use **jog shuttle & SELECT** to set the clock channel level (Level box).

Setting the Hysteresis

- Use **jog shuttle & SELECT** to set the hysteresis in the range of 0.3 to 4.0 [div] (Hysteresis box).

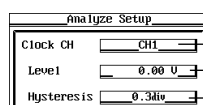

Set the clock channel to CH1 or CH3.

Set the clock channel level.

Set the hysteresis in the range of 0.3 to 4.0 [div].

- **Setting the Data Channel**

8. Use **job shuttle & SELECT** to set the data channel to CH2 or CH4 (Data CH box).

The clock channel and data channel settings are synchronized. If you set the clock channel to CH1, the data channel is set to CH2; if you set the clock channel to CH3, the data channel is set to CH4.

Setting the Threshold Level

9. Use **job shuttle & SELECT** to set the level used to determine a high level signal (Thr Upper box).
10. Likewise, use **job shuttle & SELECT** to set the level used to determine a low level signal (Thr Lower box).

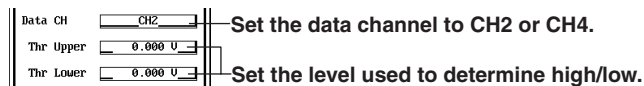

- **Setting the Analysis Reference Point-**

11. Use **job shuttle & SELECT** to select the method of setting the analysis reference point: Trigger Position or Manual.

High/Low of the mark to the left of each item indicates that it is used as an analysis reference point.

When Manually Setting the Analysis Reference Point

12. Use **job shuttle & SELECT** to set the analysis reference point in the range of –5 to +5 [div] (Manual box).

When setting the analysis reference point manually, you can enable the translucent display. This allows you to set the analysis reference point while viewing the displayed waveform. For details on the translucent display, see section 8.10, “Turning ON/OFF the Translucent Display” in the *DL1720E/DL1740E/DL1740EL User’s Manual (IM701730-01E)*.

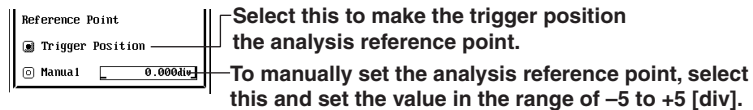

13. Press **ESC**. The Analyze Setup dialog box closes.

Executing/Aborting the Analysis

14. Press the **Analyze Exec** soft key. The data analysis is executed. The words Analyze Exec change to Analyze Abort.
To abort the data analysis, press the **Analyze Abort** soft key. The data analysis is aborted, and the words Analyze Abort change to Analyze Exec.
If indefinite data exists in the analysis data, "*" is attached to the corresponding analysis data.

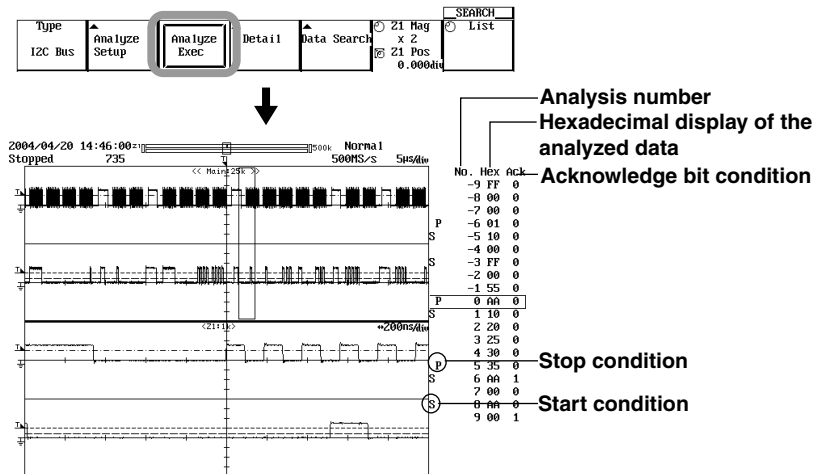

Displaying the Analysis Data

• Scrolling the List

15. Press the **List** soft key.
16. Turn the **jog shuttle** to scroll the list left and right.
Up to 20 analysis data points are displayed at once in the order of occurrence.
By scrolling the list left and right using the **jog shuttle**, analysis data beyond 20 data points can be displayed.

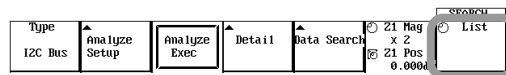

• Setting the Zoom Ratio

17. Press the **Z1 Mag/Z1 Position** soft key to set the jog shuttle control to Z1 Mag.
18. Turn the **jog shuttle** to set the zoom ratio.

• Setting the Zoom Position

19. Press the **Z1 Mag/Z1 Position** soft key to set the jog shuttle control to Z1 Position.
20. Turn the **jog shuttle** to set the zoom position. When the center of the zoom box moves to the waveform corresponding to the analysis data on the list, the corresponding analysis data on the list is highlighted.

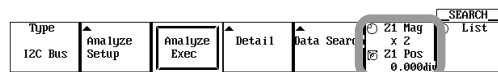

1.5 Analyzing/Searching Data

• Viewing the Details of the Analysis Data

21. Press the **Detail** soft key. A Detail dialog box opens. The analysis data of the same analysis number that is highlighted in the list in step 16 or step 20 is displayed highlighted.

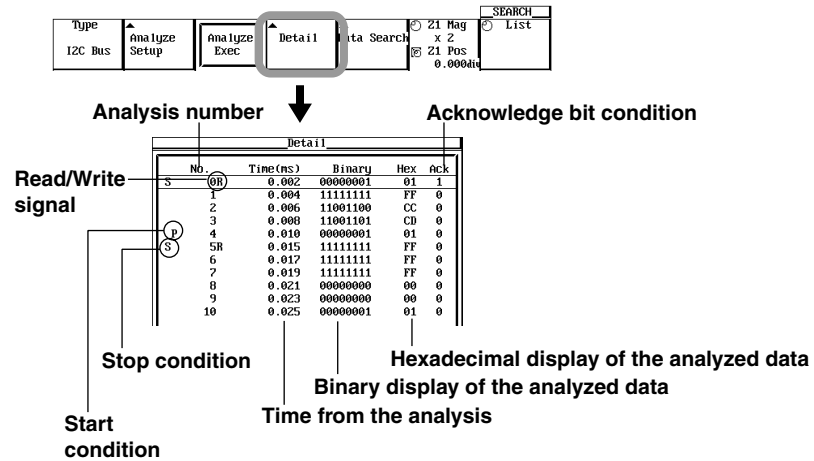

22. Press **ESC**. The Detail dialog box closes.

Note

The detailed analysis list can be saved directly to an external storage medium in ASCII format (.txt extension). For details, see section 1.6, "Saving the Data of the Detailed Analysis List."

Setting the Search Condition

23. Press the **Data Search** soft key. The Data Search menu appears.

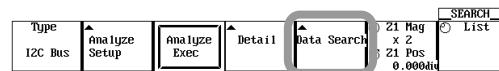

24. Press the **Search Setup** soft key. The Search Setup dialog box opens.

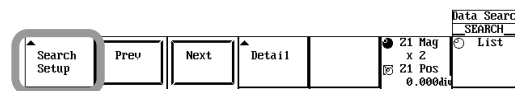

• Selecting the Search Type

25. Use **jog shuttle & SELECT** to set the search type to Byte Pattern or Indefinite State (Type box).
If you select Indefinite State, proceed to step 31.
26. If you set the search type to Byte Pattern, use the **jog shuttle & SELECT** to set the determination pattern to address pattern or data pattern.
 - Highlighting of the mark to the left of each item indicates that it is used as a determination pattern.
 - You can select the address pattern and data pattern simultaneously.

- **Setting the Address Pattern**

27. Use the **job shuttle & SELECT** set the address pattern in hexadecimal (HEX) or binary (BIN) format (HEX box or BIN box). When determination is not to be performed, select X.
 - The HEX box and BIN box settings are synchronized.
 - When using binary (BIN) notation, set the LSB of the address pattern using “R” (Read), “W” (Write), and “X.”
28. Use **jog shuttle & SELECT** to set Ack to X, 1, or 0 (Ack box).

- **Setting the Data Pattern**

29. Use the **job shuttle & SELECT** set the data pattern in hexadecimal (HEX) or binary (BIN) format (HEX box or BIN box). When determination is not to be performed, select X.

The HEX box and BIN box settings are synchronized.
30. Use **jog shuttle & SELECT** to set Ack to X, 1, or 0.

Set the search type to Byte Pattern or Indefinite State.

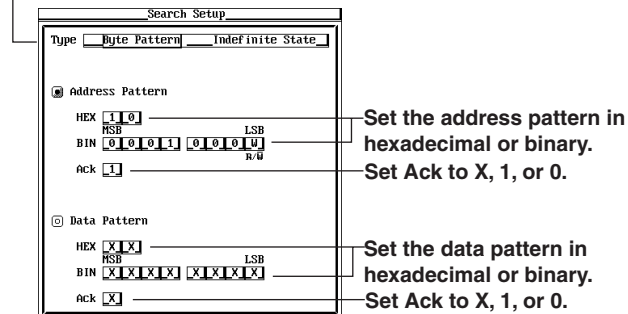

31. Press **ESC**. The Search Setup dialog box closes.

Executing the Search

32. Press the **Next** or **Previous** soft key. The search is executed.
 - When the data matches the determination pattern, the corresponding data (data that was found) is highlighted in the analysis data list at the bottom of the screen. The zoom box moves to the position so that the data that was found is at the center, and the zoomed waveform of the data that was found is displayed in the zoom waveform display area.
 - Pressing the Next soft key searches the data after the highlighted data (to the right) in the analysis data list at the bottom of the screen.
 - Pressing the Previous soft key searches the data before the highlighted data (to the left) in the analysis data list at the bottom of the screen.
 - If you selected Indefinite State (indefinite data) in step 26 and execute the search, indefinite data is highlighted.

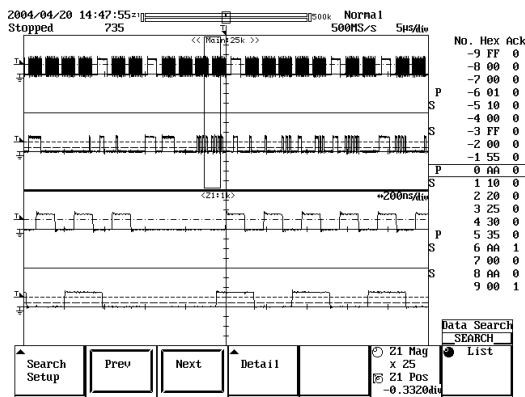

Search is performed to the left

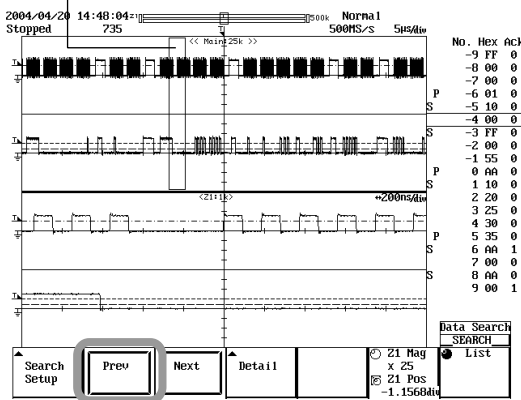

Search is performed to the right

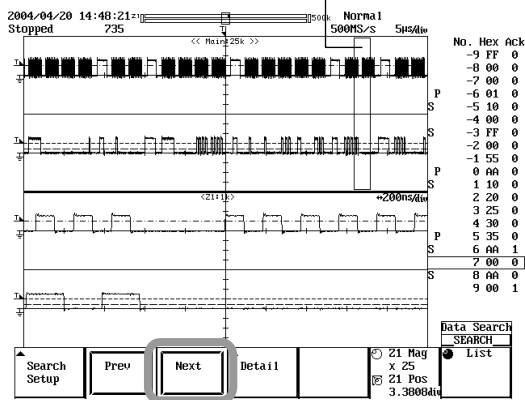

Explanation**Setting the Analysis Conditions: Analyze Setup**

You can set the following conditions.

- **Clock Channel**

Set the clock channel to CH1 or CH3. If you set the clock channel to CH1, the data channel is set to CH2; if you set the clock channel to CH3, the data channel is set to CH4.

- **Level**

Set the level used to determine the rising or falling edge of the clock signal.

Selectable range: 8 divisions within the screen

Resolution: 0.01 divisions (For example, the resolution for 2 mV/div is 0.02 mV.)

- **Hysteresis**

Selectable range: 0.3 div to 4.0 div

- **Data Channel**

Set the data channel to CH2 or CH4. If you set the data channel to CH2, the clock channel is set to CH1; if you set the data channel to CH4, the clock channel is set to CH3.

- **Setting the Threshold Level**

Set the level used to determine the data channel signal level (0, 1, or indefinite).

Thr Upper	Signal exceeding this level is determined to be 1.
-----------	--

Thr Lower	Signal below this level is determined to be 0.
-----------	--

If $\text{Thr Lower} \leq \text{data signal level} \leq \text{Thr Upper}$, the signal level is determined to be indefinite data.

If indefinite data is found, "*" is displayed in the hexadecimal display box at the byte where the indefinite data exists on the display screen of analysis results.

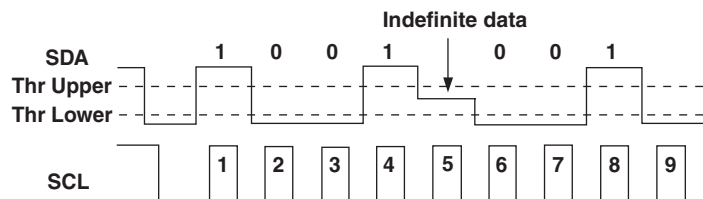

- **Analysis Reference Point**

Select the reference point used to start the analysis from the following:

Trigger Position	Sets the reference point to the trigger position.
------------------	---

Manual	You can set the reference point in the range of -5 to +5 divisions.
--------	---

- **Items to Be Analyzed**

The following types of data can be analyzed.

- Historical data.
- Data that is displayed when the waveform acquisition is stopped.
- Loaded acquisition data (ACQ data).

Analysis is performed only on the waveform selected by "Select Record" for historical data.

Range That Can Be Analyzed

Analysis is performed on the acquisition data within the display screen. Up to 40000 bytes of the analysis results can be displayed. The displayed result varies depending on the number of bytes analyzed as follows:

- **When the total analysis result is less than or equal to 40000 bytes**
All points are displayed regardless of the position of the Reference Point.
 - **When the total analysis result is greater than 40000 bytes**
The displayed result varies depending on the number of analysis results on the Pre* and Post* sides as follows:
 - When the Pre side=30000 and the Post side=30000 -> Displays Pre side=20000 and Post side=20000
 - When the Pre side=10000 and the Post side=50000 -> Displays Pre side=10000 and Post side=30000
 - When the Pre side=50000 and the Post side=10000 -> Displays Pre side=30000 and Post side=10000
- * Pre: Before (left of) the reference point
Post: After (right of) the reference point
- **Notes When Performing Analysis**
 - Analysis and search cannot be performed while the waveform acquisition is started.
 - Analysis and search cannot be performed on accumulated waveforms.

Analysis Data List (Analysis Result List)

The following three items are displayed.

- Analysis number
- Hexadecimal display of the analyzed data
- Acknowledge bit condition
- **Analysis Number: No.**
Up to 40000 points can be displayed.
- **Hexadecimal Display of the Analyzed Data: Hex**
The analyzed data is displayed using hexadecimal notation. However, if a byte of data is less than 8 bits, the data is not displayed. If indefinite data exists, "*" is displayed. Indefinite data is considered the same value as the previous bit for the analysis. If the first data is indefinite, it is considered 0 for the analysis.
- **Acknowledge Bit Condition: Ack**
Displays the Acknowledge bit condition. Displays 0 if the Acknowledge bit is present; displays 1 if the Acknowledge bit is not present.

Note

If you execute the analysis and select (highlight) an arbitrary byte in the list of analysis results, the Zoom Position moves to the head of that byte. In addition, if you move the Zoom Position, the highlighting moves to the corresponding byte in the list of analysis results.

Detailed List of Analysis Data: Detail

More detailed information of the analysis data can be listed. The following information can be displayed.

- Analysis number
- Stop condition/start condition
- Read/Write signal
- Time from the analysis reference point*
- Binary display of data
- Hexadecimal display of data
- Acknowledge bit condition

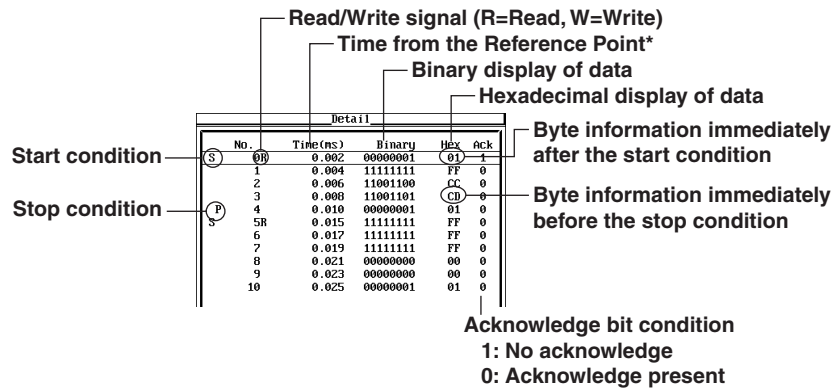

On the detailed display screen, the data corresponding to the specified number are highlighted.

On the waveform display screen, the data corresponding to the specified number is displayed in the ZOOM display.

* **About the Time(ms) display**

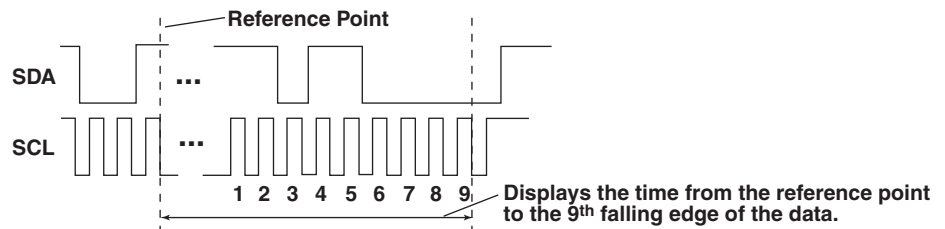

Setting the Search Condition: Search Setup

You can set the following conditions.

- **Search Type**

You can select the search type.

Byte Pattern (Pattern Search)

Searches for analysis data that matches the byte pattern.

Indefinite State (Indefinite Data Search)

Searches indefinite data from the analysis data.

- **When Search Type Is Set to Byte Pattern**

Set the byte pattern to be searched in binary or hexadecimal notation. You can set the address pattern, data pattern, and Acknowledge bit condition. Bits set to “X” are not searched.

If there is at least one “X” bit in a group of four bits in the binary display, the corresponding hexadecimal display will show an “\$.” If there is all “X” bit in a group of four bits in the binary display, the corresponding hexadecimal display will show an “X”.

- **When Search Type Is Set to Indefinite State**

Searches indefinite data from the analysis result. You cannot perform a pattern search and an indefinite data search simultaneously.

Note

Indefinite data is always considered matched to the specified status.

Executing the Search: Next, Prev

Press the Next or Prev soft key to execute the search. The search progresses (pattern or indefinite data search) as follows depending on the search type.

For Pattern Searches

Next: Searches frames after (to the right of) the currently selected frame.

Prev: Searches frames before (to the left of) the currently selected frame.

For Indefinite Data Searches

Next: Searches frames after (to the right of) the current zoom position (Z1 Pos).

Prev: Searches frames before (to the left of) the current zoom position (Z1 Pos).

- **Displaying the Search Result**

For Pattern Searches

- **When one or more Address Pattern and/or Data Patterns are selected**

If a waveform that matches the specified address pattern or data pattern is found, the zoom position (Z1 Pos) moves to the beginning the pattern.

- **If both Address Pattern and Data Pattern are OFF**

The message “Pattern is not specified.” (error code: 730) appears.

For Indefinite Data Searches

The zoom position (Z1 Pos) moves to the front of the indefinite data.

1.6 Saving the Data of the Detailed Analysis List

The data of the detailed analysis list can be saved to a file in ASCII format.

CAUTION

Do not remove the storage medium (disk) or turn OFF the power when the access indicator or icon of the storage medium is blinking. Doing so can damage the storage medium or destroy the data on the medium.

Procedure

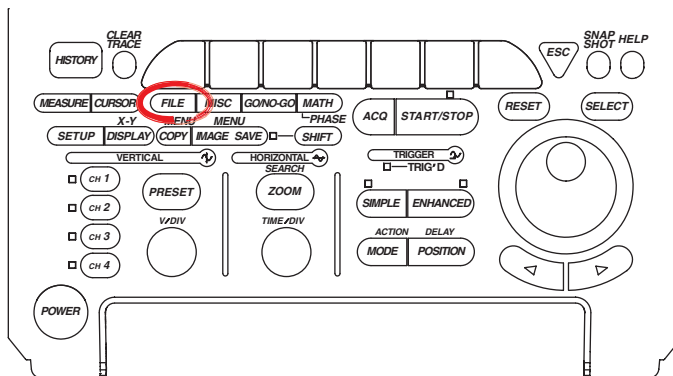

- To exit the menu during operation, press **ESC** located above the soft keys.
- In the procedural explanation below, the term *jog shuttle* & *SELECT* refers to the operation of selecting/setting items and entering values using the **jog shuttle** and **SELECT** and **RESET** keys. For details on this operation, see sections 4.1 or 4.2 in the DL1720E/DL1740E/DL1740EL User's Manual.
- For a description of the operation using a USB keyboard or a USB mouse, see section 4.3 in the DL1720E/DL1740E/DL1740EL User's Manual.

1. Press **FILE**. The FILE menu appears.
2. Press the **File Item** soft key. The File Item menu appears.



3. Press the **I²C Bus** soft key.

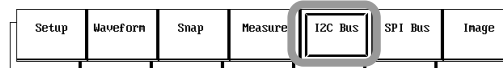

4. Press the **Save** soft key. The Save menu appears.



Selecting Save Destination Medium and Directory

5. Carry out steps 13 to 15 on page 12-14 in the *DL1720E/DL1740E/DL1740EL User's Manual (IM701730-01E)*.

Setting the File Name and Comment

6. Carry out steps 16 to 19 on page 12-14 in the *DL1720E/DL1740E/DL1740EL User's Manual (IM701730-01E)*.

1.6 Saving the Data of the Detailed Analysis List

Executing the Save Operation

- Press the **Save Exec** soft key. The data is saved to the directory indicated by Path=..... At the same time, the Save Exec soft key changes to the Abort soft key.

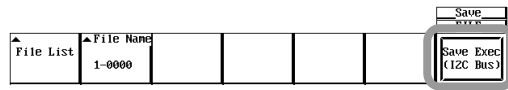

Aborting the Save Operation

- Press the **Abort** soft key. The save operation is aborted. At the same time, the Abort soft key changes to the Save Exec soft key.

Specifying the Files to Be Displayed in the File List Window and Displaying Properties

- Carry out steps 22 to 25 on page 12-15 in the *DL1720E/DL1740E/DL1740EL User's Manual (IM701730-01E)*.

Explanation

If you save the data, the data of the analysis results is saved to the specified destination in ASCII format. The file extension is .txt. The data size is (the number of analysis results × 47) + 47 bytes.

[Save example]

No.	Time(ms)	Binary	Hex	Ack
-9	-0.023	11111111	FF	0
-8	-0.021	00000000	00	0
-7	-0.019	00000000	00	0
P -6	-0.017	00000001	01	0
S -5W	-0.012	00010000	10	0
-4	-0.010	00000000	00	0
S -3R	-0.006	11111111	FF	0
-2	-0.004	00000000	00	0
-1	-0.002	01010101	55	0
P 0	-0.000	10101010	AA	0
S 1W	0.004	00010000	10	0
2	0.006	00100000	20	0
3	0.008	00100101	25	0
4	0.010	00110000	30	0
P 5	0.012	00110101	35	0
S 6W	0.016	10101010	AA	1
7	0.018	00000000	00	0
S 8W	0.023	10101010	AA	0
9	0.025	00000000	00	1

Precautions to Be Taken When Saving the Data

- The maximum number of files that can be saved when the auto naming function is ON is 1150.
- If the total number of files and directories exceed 2500 in a single directory, the contents of the File List box are no longer displayed.

1.7 Error Messages

A message may appear during operation. This section describes the meanings of the messages and their corrective actions. This section lists only the error messages related to the I²C Bus signal analysis function. There are other error messages related to the DL7440/DL7480 and communications. These messages are described in the *DL1720E/DL1740E/DL1740EL User's Manual (IM701730-01E)* and the *DL1720E/DL1740E/DL1740EL Communication Interface User's Manual (IM701730-17E)*.

You can set the messages to be displayed in English or Japanese. For the procedure of setting the message language, see section 15.1, "Changing the Menu Language/ Message Language and Turning ON/OFF the Click Sound" in the *DL1720E/DL1740E/DL1740EL User's Manual (IM701730-01E)*.

If the corrective action requires servicing, contact your nearest YOKOGAWA dealer for repairs.

Code	Message	Action	Page
37	Aborted the analysis.	–	1-26
38	Data not detected. Execute again after changing the settings or reacquiring the waveform.	–	1-4, 1-10, 1-25, 1-31
730	Pattern is not specified.	Enable Address Pattern or Data Pattern in the Search Setup dialog box.	1-29
739	Analyzed data does not exist. Execute the analysis.	Execute the analysis.	1-26, 1-31
870	Cannot be specified. Invalid byte or bit.	Increase the number of valid bytes.	1-6, 1-11

1.8 Communication Commands

This section contains only the communication commands related to the I²C Bus signal analysis function. For a description of other DL1740E/DL1740EL communication commands, see the *DL1720E/DL1740E/DL1740EL Communication Interface User's Manual (IM701730-17E)*.

Command	Function	Page
I²C Analyze Group		
:SEARCH:I2C?	Queries all settings related to the analysis* function.	1-41
:SEARCH:I2C:ANALyze?	Queries all settings related to the execution of the analysis.*	1-41
:SEARCH:I2C:ANALyze:ABORT	Aborts the execution of the Analysis.*	1-41
:SEARCH:I2C:ANALyze:EXECute	Executes the analysis.*	1-41
:SEARCH:I2C:ANALyze:SETup?	Queries all settings related to the analysis* conditions.	1-41
:SEARCH:I2C:ANALyze:SETup:CLOCK?	Queries all settings related to the clock channel of the analysis* conditions.	1-41
:SEARCH:I2C:ANALyze:SETup:CLOCK:HYSteresis	Sets the clock channel hysteresis of the analysis* conditions or queries the current setting.	1-41
:SEARCH:I2C:ANALyze:SETup:CLOCK:LEVel	Sets the clock channel level of the analysis* conditions or queries the current setting.	1-42
:SEARCH:I2C:ANALyze:SETup:CLOCK:SOURce	Sets the clock channel source waveform of the analysis* conditions or queries the current setting.	1-42
:SEARCH:I2C:ANALyze:SETup:DATA?	Queries all settings related to the data channel of the analysis* conditions.	1-42
:SEARCH:I2C:ANALyze:SETup:DATA:LEVel	Sets the threshold level of the data channel of the analysis* conditions or queries the current setting.	1-42
:SEARCH:I2C:ANALyze:SETup:DATA:SOURce	Sets the data channel source waveform of the analysis* conditions or queries the current setting.	1-42
:SEARCH:I2C:ANALyze:SETup:MPOSition	Sets the reference position when the analysis* reference point is set manually or queries the current setting.	1-42
:SEARCH:I2C:ANALyze:SETup:RPOint	Set whether to make the trigger point the analysis* reference point or set the reference point manually.	1-43
:SEARCH:I2C:LIST? {<Nrf>}	Outputs one byte of analysis* result as a character string.	1-43
:SEARCH:I2C:SEARCh?	Queries all settings related to the analysis* result search.	1-43
:SEARCH:I2C:SEARCh:ADDRess?	Queries all settings related to the address pattern search on the analysis* result.	1-43
:SEARCH:I2C:SEARCh:ADDRess:ACK	Sets the Ack condition of the address pattern search on the analysis* result or queries the current setting.	1-43
:SEARCH:I2C:SEARCh:ADDRess:HEXa	Sets the pattern of the address pattern search on the analysis* result in hexadecimal.	1-43
:SEARCH:I2C:SEARCh:ADDRess:MODE	Enables or disables the address pattern when searching the analysis* result or queries the current setting.	1-43
:SEARCH:I2C:SEARCh:ADDRess:PATtern	Sets the pattern of the address pattern search on the analysis* result in binary or queries the current setting.	1-43
:SEARCH:I2C:SEARCh:DATA?	Queries all settings related to the data pattern search on the analysis* result.	1-43
:SEARCH:I2C:SEARCh:DATA:ACK	Sets the Ack condition of the search using the data pattern on the analysis* result or queries the current setting.	1-43
:SEARCH:I2C:SEARCh:DATA:HEXa	Sets the pattern of the data pattern search on the analysis* result in hexadecimal.	1-44
:SEARCH:I2C:SEARCh:DATA:MODE	Enables or disables the data pattern when searching the analysis* result or queries the current setting.	1-44
:SEARCH:I2C:SEARCh:DATA:PATtern	Sets the pattern of the data pattern search on the analysis* result in binary or queries the current setting.	1-44

Command	Function	Page
:SEARCH:I2C:SEARCH:NEXT?	Performs the analysis* result search on the data after the current byte and returns the search position.	1-44
:SEARCH:I2C:SEARCH:PREVIOUS?	Performs the analysis* result search on the data before the current byte and returns the search position.	1-44
:SEARCH:I2C:SEARCH:TYPE	Sets the analysis result search type or queries the current setting.	1-44
:SEARCH:TYPE	Sets the search type or queries the current setting.	1-44
I²C File Group		
:FILE:SAVE:I2C:ABORT	Aborts the saving of the data of the detailed analysis list of the analysis.*	1-45
:FILE:SAVE:I2C[:EXECUTE]	Executes the saving of the data of the detailed analysis list of the analysis* (overlap command).	1-45
I²C Trigger Group		
:TRIGGER:I2C?	Queries all settings related to the trigger.*	1-47
:TRIGGER:I2C:ADDRESS?	Queries all settings related to the Adrs&Data trigger.*	1-47
:TRIGGER:I2C:ADDRESS:ABCOUNT	Sets the byte data location for comparing the Data2 Pattern when using Adrs&Data trigger* or queries the current setting.	1-47
:TRIGGER:I2C:ADDRESS:ADDRESS?	Queries all settings related to the address pattern setting for the Adrs&Data trigger.*	1-47
:TRIGGER:I2C:ADDRESS:ADDRESS:HEXA	Sets the address pattern for the Adrs&Data trigger* in hexadecimal.	1-47
:TRIGGER:I2C:ADDRESS:ADDRESS:MODE	Enables or disables the address pattern for the Adrs&Data trigger* or queries the current setting.	1-48
:TRIGGER:I2C:ADDRESS:ADDRESS:PATTERN	Sets the address pattern for the Adrs&Data trigger* in binary or queries the current setting.	1-48
:TRIGGER:I2C:ADDRESS:DATA<x>?	Queries all settings related to each address pattern setting for the Adrs&Data trigger.*	1-48
:TRIGGER:I2C:ADDRESS:DATA<x>:CONDITION	Sets the condition of each data pattern for the Adrs&Data trigger* or queries the current setting.	1-48
:TRIGGER:I2C:ADDRESS:DATA<x>:DBYTE	Sets the number of bytes of the data pattern (Data2 Pattern) for the Adrs&Data trigger* or queries the current setting.	1-48
:TRIGGER:I2C:ADDRESS:DATA<x>:HEXA<y>	Sets each data pattern for the Adrs&Data trigger* in hexadecimal.	1-48
:TRIGGER:I2C:ADDRESS:DATA<x>:MODE	Enables or disables each data pattern for the Adrs&Data trigger* or queries the current setting.	1-48
:TRIGGER:I2C:ADDRESS:DATA<x>:PATTERN<y>	Sets each data pattern for the Adrs&Data trigger* in binary or queries the current setting.	1-48
:TRIGGER:I2C:BCOUNT	Sets the byte count for the Adrs&Data trigger* or queries the current setting.	1-49
:TRIGGER:I2C:COMBINATION	Sets the combination trigger* or queries the current setting.	1-49
:TRIGGER:I2C:IRESTART	Sets whether to ignore the restart condition (YES/NO) of the trigger* or queries the current setting.	1-49
:TRIGGER:I2C:IUNEXPECTED	Sets whether to ignore the start/stop conditions that do not conform to the protocol (YES/NO) of the trigger* or queries the current setting.	1-49
:TRIGGER:I2C:PATTERN?	Queries all settings related to each channel pattern setting of the combination trigger.*	1-49
:TRIGGER:I2C:PATTERN:CHANNEL<x>	Sets the condition (pattern or slope) of each channel of the combination trigger* or queries the current setting.	1-49
:TRIGGER:I2C:PATTERN:CLOCK	Sets the clock channel of the combination trigger* or queries the current setting.	1-49
:TRIGGER:I2C:PATTERN:CONDITION	Sets the pattern condition of the combination trigger* or queries the current setting.	1-49
:TRIGGER:I2C:TYPE	Sets the trigger* type or queries the current setting.	1-49
:TRIGGER:TYPE	Sets the trigger type or queries the current setting.	1-50

* In the explanation of the function of each command in this section, *analysis* refers to I²C Bus signal analysis. *Trigger* refers to the trigger of the I²C Bus signal analysis function.

1.8 Communication Commands

• I²C Analyze Group

Commands in the I²C Analyze group can be used to make the same settings, inquiries, and executions as when the I²C bus menu under the SHIFT + ZOOM key on the front panel is used.

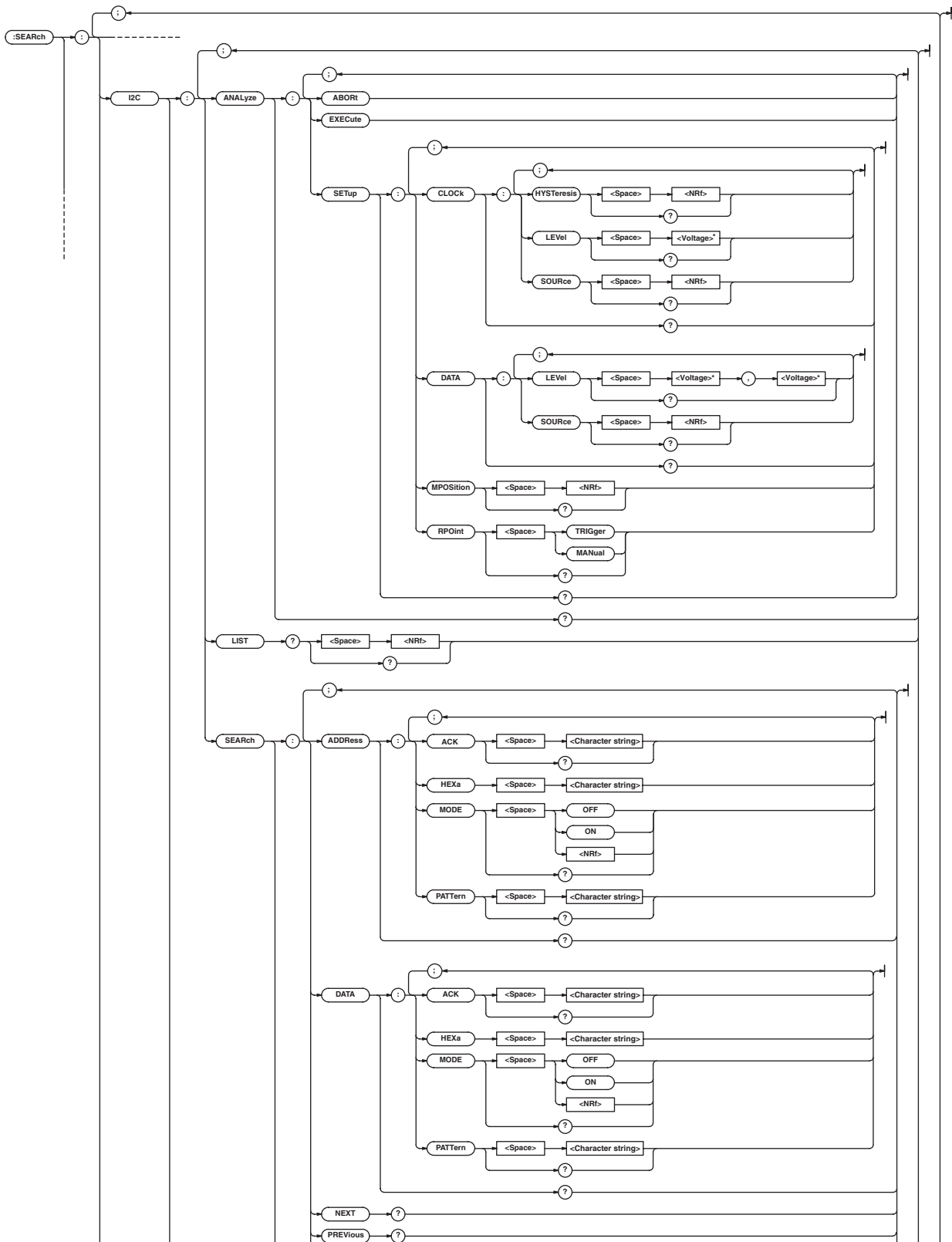

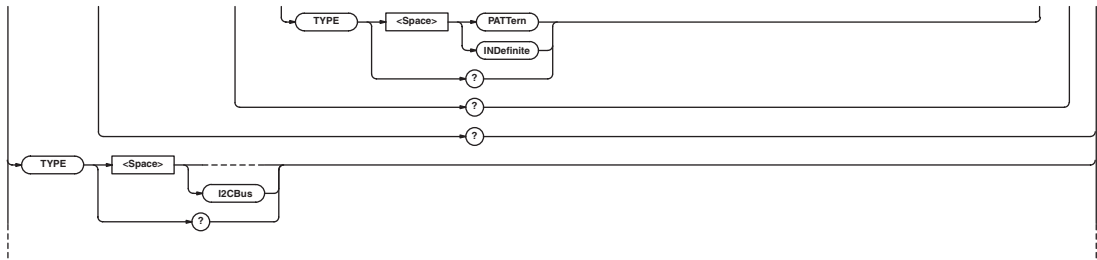

* <Current> when a current probe is used.

:SEARCH:I2C?

Function Queries all settings related to the analysis function.

Syntax :SEARCH:I2C?

Example :SEARCH:I2C? -> :SEARCH:I2C:
ANALYZE:SETUP:CLOCK:SOURCE 1;
LEVEL 1.000E+00;HYSTERESIS 0.3;:
SEARCH:I2C:ANALYZE:SETUP:DATA:
SOURCE 2;
LEVEL 1.000E+00,0.000E+00;:
SEARCH:I2C:ANALYZE:SETUP::
RPOINT TRIGGER;MPOSITION -4.00000;:
SEARCH:I2C:SEARCH:TYPE PATTERN;
ADDRESS:MODE 1;PATTERN "X0X10X10";
ACK "X";:SEARCH:I2C:SEARCH:DATA:
MODE 1;PATTERN "10X10X10";ACK "X"

:SEARCH:I2C:ANALYZE?

Function Queries all settings related to the execution of the analysis.

Syntax :SEARCH:I2C:ANALYZE?

Example :SEARCH:I2C:ANALYZE? ->
:SEARCH:I2C:
ANALYZE:SETUP:CLOCK:SOURCE 1;
LEVEL 1.000E+00;HYSTERESIS 0.3;:
SEARCH:I2C:ANALYZE:SETUP:DATA:
SOURCE 2;
LEVEL 1.000E+00,0.000E+00;:
SEARCH:I2C:ANALYZE:SETUP::
RPOINT TRIGGER;MPOSITION -4.00000

:SEARCH:I2C:ANALYZE:ABORT

Function Aborts the execution of the Analysis.

Syntax :SEARCH:I2C:ANALYZE:ABORT

Example :SEARCH:I2C:ANALYZE:ABORT

:SEARCH:I2C:ANALYZE:EXECUTE

Function Executes the analysis.

Syntax :SEARCH:I2C:ANALYZE:EXECUTE

Example :SEARCH:I2C:ANALYZE:EXECUTE

:SEARCH:I2C:ANALYZE:SETUP?

Function Queries all settings related to the analysis conditions.

Syntax :SEARCH:I2C:ANALYZE:SETUP?

Example :SEARCH:I2C:ANALYZE:SETUP? ->
:SEARCH:I2C:ANALYZE:SETUP:CLOCK:
SOURCE 1;LEVEL 1.000E+00;
HYSTERESIS 0.3;:SEARCH:I2C:ANALYZE:
SETUP:DATA:SOURCE 2;
LEVEL 1.000E+00,0.000E+00;:
SEARCH:I2C:ANALYZE:SETUP::
RPOINT TRIGGER;MPOSITION -4.00000

:SEARCH:I2C:ANALYZE:SETUP:CLOCK?

Function Queries all settings related to the clock channel of the analysis conditions.

Syntax :SEARCH:I2C:ANALYZE:SETUP:CLOCK?

Example :SEARCH:I2C:ANALYZE:SETUP:CLOCK? ->
:SEARCH:I2C:ANALYZE:SETUP:CLOCK:
SOURCE 1;LEVEL 1.000E+00;
HYSTERESIS 0.3

:SEARCH:I2C:ANALYZE:SETUP:CLOCK:HYSTERESIS

Function Sets the clock channel hysteresis of the analysis conditions or queries the current setting.

Syntax :SEARCH:I2C:ANALYZE:SETUP:CLOCK:
HYSTERESIS {<NRf>}
:SEARCH:I2C:ANALYZE:SETUP:CLOCK:
HYSTERESIS?
<NRf>=0.3 to 4.0 (div, 0.1 steps)

Example :SEARCH:I2C:ANALYZE:SETUP:CLOCK:
HYSTERESIS 0.5
:SEARCH:I2C:ANALYZE:SETUP:CLOCK:
HYSTERESIS? -> :SEARCH:I2C:ANALYZE:
SETUP:CLOCK:HYSTERESIS 0.5

1.8 Communication Commands

:SEARCH:I2C:ANALyze:SETup:CLOCK:LEVel

Function	Sets the clock channel level of the analysis conditions or queries the current setting.
Syntax	<pre>:SEARCH:I2C:ANALyze:SETup:CLOCK:LEVel {<Voltage>} :SEARCH:I2C:ANALyze:SETup:CLOCK:LEVel? <Voltage>=8 divisions within the screen (0.01 division steps).</pre>
Example	<pre>:SEARCH:I2C:ANALyze:SETup:CLOCK:LEVel 1V :SEARCH:I2C:ANALyze:SETup:CLOCK:LEVel? -> :SEARCH:I2C:ANALyze:SETup:CLOCK:LEVel 1.000E+00</pre>
Description	If you are setting a clock channel to which a current probe is connected, set and query using <Current>.

:SEARCH:I2C:ANALyze:SETup:CLOCK:SOURce

Function	Sets the clock channel source waveform of the analysis conditions or queries the current setting.
Syntax	<pre>:SEARCH:I2C:ANALyze:SETup:CLOCK:SOURce {<NRf>} :SEARCH:I2C:ANALyze:SETup:CLOCK:SOURce? <NRf>=1, 3</pre>
Example	<pre>:SEARCH:I2C:ANALyze:SETup:CLOCK:SOURce 1 :SEARCH:I2C:ANALyze:SETup:CLOCK:SOURce? -> :SEARCH:I2C:ANALyze:SETup:CLOCK:SOURce 1</pre>

:SEARCH:I2C:ANALyze:SETup:DATA?

Function	Queries all settings related to the data channel of the analysis conditions.
Syntax	<pre>:SEARCH:I2C:ANALyze:SETup:DATA?</pre>
Example	<pre>:SEARCH:I2C:ANALyze:SETup:DATA? -> :SEARCH:I2C:ANALyze:SETup:DATA:SOURce 2;LEVel 1.000E+00,0.000E+00</pre>

:SEARCH:I2C:ANALyze:SETup:DATA:LEVel

Function	Sets the threshold level of the data channel of the analysis conditions or queries the current setting.
Syntax	<pre>:SEARCH:I2C:ANALyze:SETup:DATA:LEVel {<Voltage>,<Voltage>} :SEARCH:I2C:ANALyze:SETup:DATA:LEVel? <Voltage>=8 divisions within the screen (0.01 division steps).</pre>
Example	<pre>:SEARCH:I2C:ANALyze:SETup:DATA:LEVel 1V,0V :SEARCH:I2C:ANALyze:SETup:DATA:LEVel? -> :SEARCH:I2C:ANALyze:SETup:DATA:LEVel 1.000E+00,0.000E+00</pre>
Description	If you are setting a data channel to which a current probe is connected, set and query using <Current>.-

:SEARCH:I2C:ANALyze:SETup:DATA:SOURce

Function	Sets the data channel source waveform of the analysis conditions or queries the current setting.
Syntax	<pre>:SEARCH:I2C:ANALyze:SETup:DATA:SOURce {<NRf>} :SEARCH:I2C:ANALyze:SETup:DATA:SOURce? <NRf>=2, 4</pre>
Example	<pre>:SEARCH:I2C:ANALyze:SETup:DATA:SOURce 2 :SEARCH:I2C:ANALyze:SETup:DATA:SOURce? -> :SEARCH:I2C:ANALyze:SETup:DATA:SOURce 2</pre>

:SEARCH:I2C:ANALyze:SETup:MPOStion

Function	Sets the reference position when the analysis reference point is set manually or queries the current setting.
Syntax	<pre>:SEARCH:I2C:ANALyze:SETup:MPOStion {<NRf>} :SEARCH:I2C:ANALyze:SETup:MPOStion? <NRf>=-5 to 5 divisions (10 divisions/displayed record length steps)</pre>
Example	<pre>:SEARCH:I2C:ANALyze:SETup:MPOStion -4.000 :SEARCH:I2C:ANALyze:SETup:MPOStion? -> :SEARCH:I2C:ANALyze:SETup:MPOStion -4.00000</pre>

:SEARCH:I2C:ANALyze:SETup:RPOint

Function Set whether to make the trigger point the analysis reference point or set the reference point manually.

Syntax :SEARCH:I2C:ANALyze:SETup:RPOint {TRIGger|MANual}

Example :SEARCH:I2C:ANALyze:SETup:RPOint? RPOINT TRIGGER

:SEARCH:I2C:LIST? {<NRf>}

Function Outputs one byte of analysis result as a character string.

Syntax :SEARCH:I2C:LIST? {<NRf>} <NRf>=-40000 to 40000

Example :SEARCH:I2C:LIST? 1 ->
" 1 0.024 0001111 0F 0"

:SEARCH:I2C:SEARCH?

Function Queries all settings related to the analysis result search.

Syntax :SEARCH:I2C:SEARCH?

Example :SEARCH:I2C:SEARCH? -> :SEARCH:I2C:SEARCH:TYPE PATTERN;ADDRESS:MODE 1;PATTERN "X0X10X10";ACK "X";:SEARCH:I2C:SEARCH:DATA:MODE 1;PATTERN "10X10X10";ACK "X"

:SEARCH:I2C:SEARCH:ADDRESS?

Function Queries all settings related to the address pattern search on the analysis result.

Syntax :SEARCH:I2C:SEARCH:ADDRESS?

Example :SEARCH:I2C:SEARCH:ADDRESS? -> :SEARCH:I2C:SEARCH:ADDRESS:MODE 1;PATTERN "X0X10X10";ACK "X"

:SEARCH:I2C:SEARCH:ADDRESS:ACK

Function Sets the Ack condition of the search using the address pattern on the analysis result or queries the current setting.

Syntax :SEARCH:I2C:SEARCH:ADDRESS:ACK {<String>} :SEARCH:I2C:SEARCH:ADDRESS:ACK? <String>='0','1','X'

Example :SEARCH:I2C:SEARCH:ADDRESS:ACK "X" :SEARCH:I2C:SEARCH:ADDRESS:ACK? -> :SEARCH:I2C:SEARCH:ADDRESS:ACK "X"

:SEARCH:I2C:SEARCH:ADDRESS:HEXA

Function Sets the pattern of the address pattern search on the analysis result in hexadecimal.

Syntax :SEARCH:I2C:SEARCH:ADDRESS:HEXA {<String>} <String>=2 characters by combining '0' to 'F' and 'X'

Example :SEARCH:I2C:SEARCH:ADDRESS:HEXA "1A"

:SEARCH:I2C:SEARCH:ADDRESS:MODE

Function Enables or disables the address pattern when searching the analysis result or queries the current setting.

Syntax :SEARCH:I2C:SEARCH:ADDRESS:MODE {<Boolean>} :SEARCH:I2C:SEARCH:ADDRESS:MODE?

Example :SEARCH:I2C:SEARCH:ADDRESS:MODE ON :SEARCH:I2C:SEARCH:ADDRESS:MODE? -> :SEARCH:I2C:SEARCH:ADDRESS:MODE 1

:SEARCH:I2C:SEARCH:ADDRESS:PATTERN

Function Sets the pattern of the address pattern search on the analysis result in binary or queries the current setting.

Syntax :SEARCH:I2C:SEARCH:ADDRESS:PATTERN {<String>} :SEARCH:I2C:SEARCH:ADDRESS:PATTERN? <String>=8 characters by combining '0','1,' and 'X' (The 8th character is the R/W bit.)

Example :SEARCH:I2C:SEARCH:ADDRESS:PATTERN "X0X10X10" :SEARCH:I2C:SEARCH:ADDRESS:PATTERN? -> :SEARCH:I2C:SEARCH:ADDRESS:PATTERN "X0X10X10"

:SEARCH:I2C:SEARCH:DATA?

Function Queries all settings related to the data pattern search on the analysis result.

Syntax :SEARCH:I2C:SEARCH:DATA?

Example :SEARCH:I2C:SEARCH:DATA? -> :SEARCH:I2C:SEARCH:DATA:MODE 1;PATTERN "10X10X10";ACK "X"

:SEARCH:I2C:SEARCH:DATA:ACK

Function Sets the Ack condition of the search using the data pattern on the analysis result or queries the current setting.

Syntax :SEARCH:I2C:SEARCH:DATA:ACK {<String>} :SEARCH:I2C:SEARCH:DATA:ACK? <String>='0','1','X'

Example :SEARCH:I2C:SEARCH:DATA:ACK "X" :SEARCH:I2C:SEARCH:DATA:ACK? -> :SEARCH:I2C:SEARCH:DATA:ACK "X"

1.8 Communication Commands

:SEARCH:I2C:SEARCH:DATA:HEXa

Function Sets the pattern of the data pattern search on the analysis result in hexadecimal.

Syntax :SEARCH:I2C:SEARCH:DATA:HEXa
{<String>}
<String>=2 characters by combining '0' to 'F' and 'X'

Example :SEARCH:I2C:SEARCH:DATA:HEXa "2B"
:SEARCH:I2C:SEARCH:DATA:HEXa? ->
:SEARCH:I2C:SEARCH:DATA:HEXa "2B"

:SEARCH:I2C:SEARCH:DATA:MODE

Function Enables or disables the data pattern when searching the analysis result or queries the current setting.

Syntax :SEARCH:I2C:SEARCH:DATA:MODE
{<Boolean>}

Example :SEARCH:I2C:SEARCH:DATA:MODE ON
:SEARCH:I2C:SEARCH:DATA:MODE? ->
:SEARCH:I2C:SEARCH:DATA:MODE 1

:SEARCH:I2C:SEARCH:DATA:PATtern

Function Sets the pattern of the data pattern search on the analysis result in binary or queries the current setting.

Syntax :SEARCH:I2C:SEARCH:DATA:PATtern
{<String>}
:SEARCH:I2C:SEARCH:DATA:PATtern?
<String>=8 characters by combining '0,' '1,' and 'X'
(The 8th character is the R/W bit.)

Example :SEARCH:I2C:SEARCH:DATA:
PATtern "10X10X10"
:SEARCH:I2C:SEARCH:DATA:PATtern? ->
:SEARCH:I2C:SEARCH:DATA:
PATtern "10X10X10"

:SEARCH:I2C:SEARCH:NEXT?

Function Performs the analysis result search on the data after the current byte and returns the search position.

Syntax :SEARCH:I2C:SEARCH:NEXT?

Example :SEARCH:I2C:SEARCH:NEXT? -> 10

Description If the search is successful, a value in the range of -40000 to 40000 is returned. If it fails, "NAN" is returned.

:SEARCH:I2C:SEARCH:PREVIOUS?

Function Performs the analysis result search on the data before the current byte and returns the search position.

Syntax :SEARCH:I2C:SEARCH:PREVIOUS?

Example :SEARCH:I2C:SEARCH:PREVIOUS? -> -10

Description If the search is successful, a value in the range of -40000 to 40000 is returned. If it fails, "NAN" is returned.

:SEARCH:I2C:SEARCH:TYPE

Function Sets the analysis result search type or queries the current setting.

Syntax :SEARCH:I2C:SEARCH:TYPE
{PATtern|INDefinite}
:SEARCH:I2C:SEARCH:TYPE?

Example :SEARCH:I2C:SEARCH:TYPE PATtern
:SEARCH:I2C:SEARCH:TYPE? ->
:SEARCH:I2C:SEARCH:TYPE PATtern

:SEARCH:TYPE

Function Sets the search type or queries the current setting.

Syntax :SEARCH:TYPE {SPATtern|WIDTh|EDGE|
PPATtern|ASCRoll|I2CBus|SPIBus}
:SEARCH:TYPE?

Example :SEARCH:TYPE I2CBUS
:SEARCH:TYPE? -> :SEARCH:
TYPE I2CBUS

- **I²C File Group**

Commands in the I²C File group can be used to make the same settings, inquiries, and executions as when the I²C bus menu under the FILE key on the front panel is used.

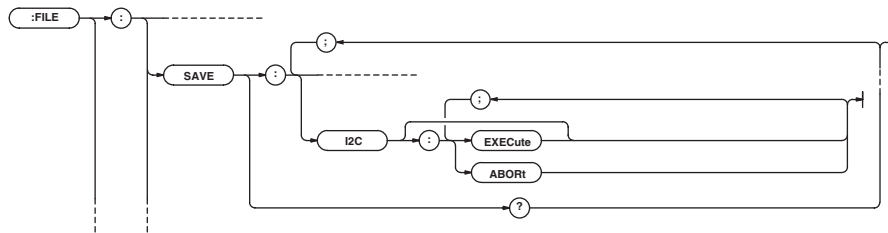

:FILE:SAVE:I2C:ABORt

Function Aborts the saving of the data of the detailed analysis list of the analysis.

Syntax :FILE:SAVE:I2C:ABORt

Example :FILE:SAVE:I2C:ABORT

:FILE:SAVE:I2C[:EXECute]

Function Executes the saving of the data of the detailed analysis list of the analysis This is an overlap command.

Syntax :FILE:SAVE:I2C[:EXECute]

Example :FILE:SAVE:I2C:EXECUTE

1.8 Communication Commands

• I²C Trigger Group

Commands in the I²C Trigger group can be used to make the same settings and inquiries as when the I²C bus menu under the ENHANCED key on the front panel is used.

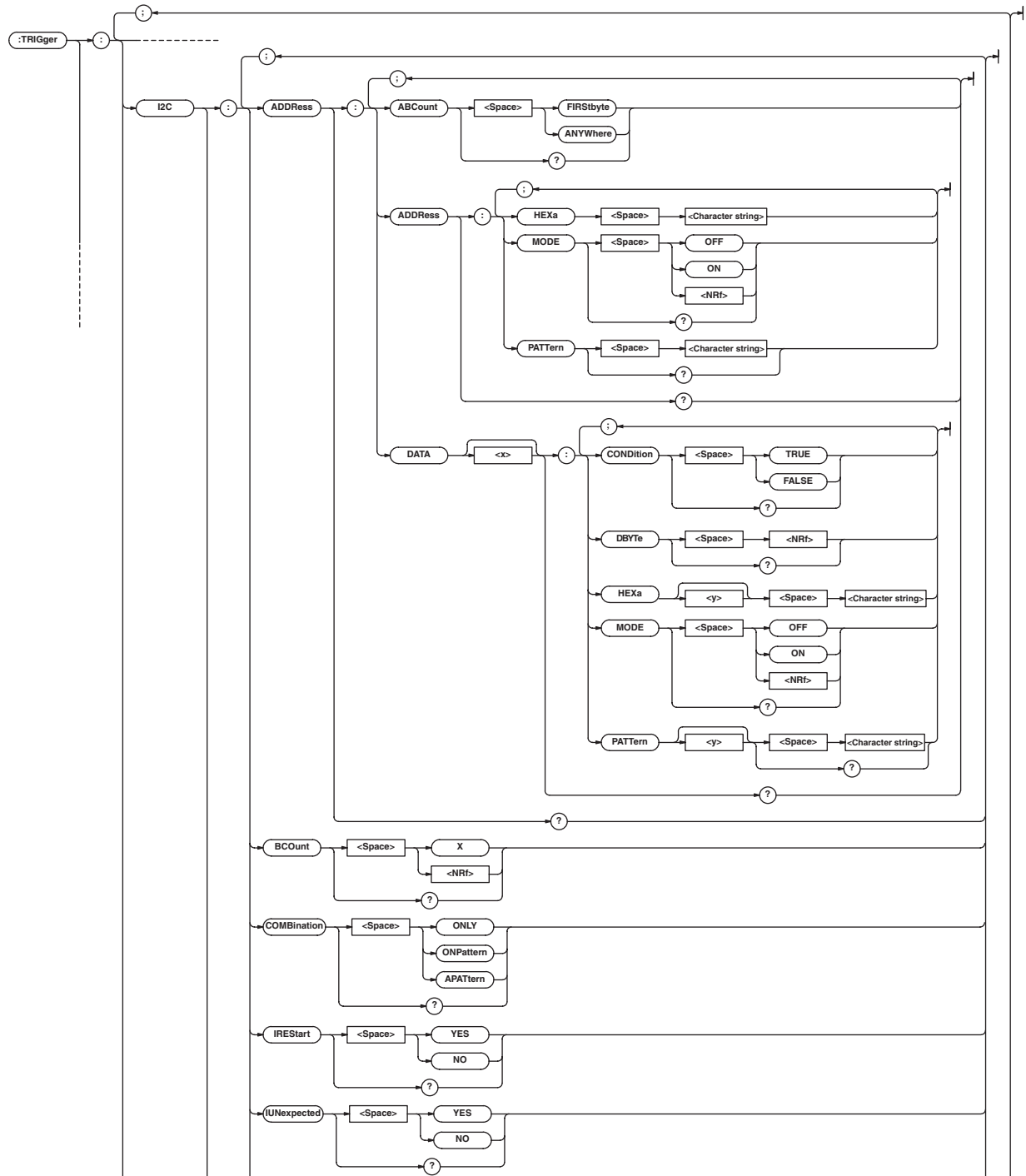

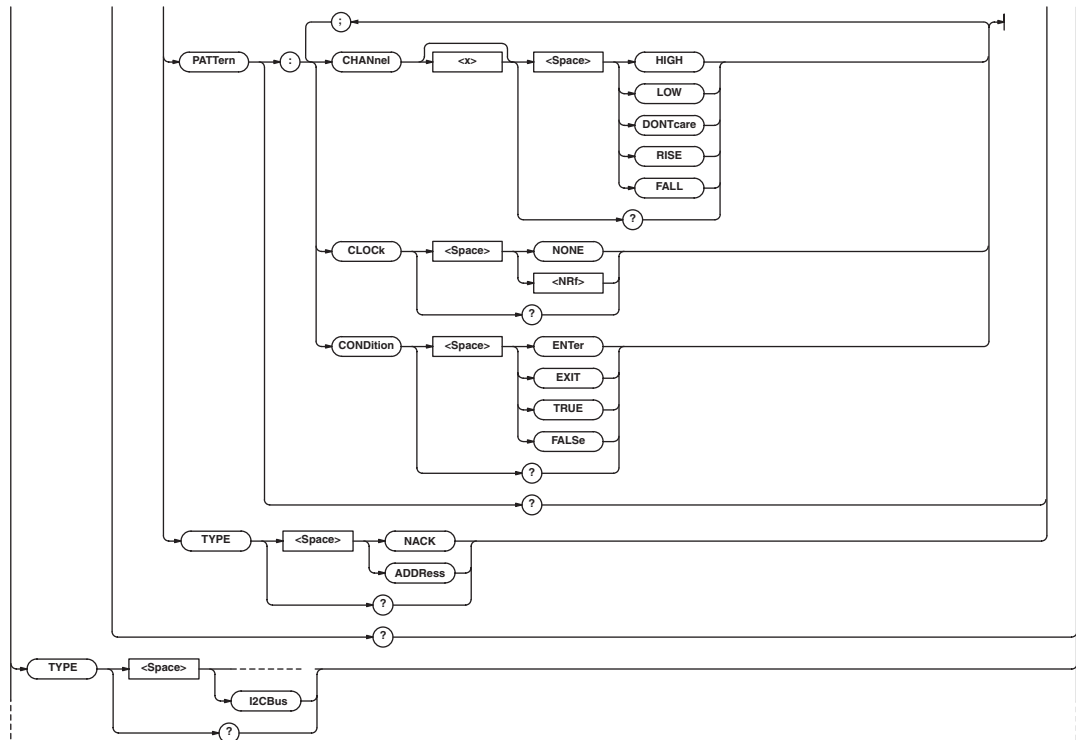

:TRIGger:I2C?

Function Queries all settings related to the trigger.
 Syntax :TRIGger:I2C?
 Example :TRIGGER:I2C? -> :TRIGGER:I2C:
 COMBINATION ONLY;TYPE ADDRESS;
 ADDRESS:ADDRESS:MODE 0;
 PATTERN "XXXXXXXX";:TRIGGER:I2C:
 ADDRESS:DATA1:MODE 0;
 PATTERN1 "XXXXXXXX";
 CONDITION TRUE;:TRIGGER:I2C:
 ADDRESS:DATA2:D BYTE 2;MODE 0;
 PATTERN1 "XXXXXXXX";
 PATTERN2 "XXXXXXXX";
 CONDITION TRUE;:TRIGGER:I2C:
 ADDRESS:ABCOUNT FIRSTBYTE;:TRIGGER:
 I2C:I RESTART NO;IUNEXPECTED NO;
 BCOUNT 0

:TRIGger:I2C:ADDRESS?

Function Queries all settings related to the Adrs&Data trigger.
 Syntax :TRIGger:I2C:ADDRESS?
 Example :TRIGGER:I2C:ADDRESS? -> :TRIGGER:
 I2C:ADDRESS:ADDRESS:MODE 0;
 PATTERN "XXXXXXXX";:TRIGGER:I2C:
 ADDRESS:DATA1:MODE 0;
 PATTERN1 "XXXXXXXX";
 CONDITION TRUE;:TRIGGER:I2C:
 ADDRESS:DATA2:D BYTE 2;MODE 0;
 PATTERN1 "XXXXXXXX";
 PATTERN2 "XXXXXXXX";CONDITION
 TRUE;:TRIGGER:I2C:ADDRESS:
 ABCOUNT FIRSTBYTE

:TRIGger:I2C:ADDRESS:ABCount

Function Sets the byte data location for comparing the Data2 Pattern when using Adrs&Data trigger or queries the current setting.
 Syntax :TRIGger:I2C:ADDRESS:ABCount
 {FIRSTbyte|ANYWhere}
 :TRIGger:I2C:ADDRESS:ABCount?
 Example :TRIGGER:I2C:ADDRESS:ABCOUNT
 FIRSTBYTE
 :TRIGGER:I2C:ADDRESS:ABCOUNT? ->
 :TRIGGER:I2C:ADDRESS:
 ABCOUNT FIRSTBYTE

:TRIGger:I2C:ADDRESS:ADDRESS?

Function Queries all settings related to the address pattern setting for the Adrs&Data trigger.
 Syntax :TRIGger:I2C:ADDRESS:ADDRESS?
 Example :TRIGGER:I2C:ADDRESS:ADDRESS? ->
 :TRIGGER:I2C:ADDRESS:ADDRESS:
 MODE 0;PATTERN "X0X10X10"

:TRIGger:I2C:ADDRESS:ADDRESS:HEXa

Function Sets the address pattern for the Adrs&Data trigger in hexadecimal.
 Syntax :TRIGger:I2C:ADDRESS:ADDRESS:HEXa
 {<String>}
 <String>=2 characters by combining '0' to 'F' and 'X'
 Example :TRIGGER:I2C:ADDRESS:ADDRESS:
 HEXA "1A"

1.8 Communication Commands

:TRIGger:I2C:ADDRESS:ADDRESS:MODE

Function Enables or disables the address pattern for the Adrs&Data trigger or queries the current setting.

Syntax :TRIGger:I2C:ADDRESS:ADDRESS:MODE {<Boolean>}
:TRIGger:I2C:ADDRESS:ADDRESS:MODE?

Example :TRIGGER:I2C:ADDRESS:ADDRESS:MODE ON
:TRIGGER:I2C:ADDRESS:ADDRESS:MODE? ->:TRIGGER:I2C:ADDRESS:ADDRESS:MODE 1

:TRIGger:I2C:ADDRESS:ADDRESS:PATtern

Function Sets the address pattern for the Adrs&Data trigger in binary or queries the current setting.

Syntax :TRIGger:I2C:ADDRESS:ADDRESS:PATtern {<String>}
:TRIGger:I2C:ADDRESS:ADDRESS:PATtern? <String>=8 characters by combining '0,' '1,' and 'X' (The 8th character is the R/W bit.)

Example :TRIGGER:I2C:ADDRESS:ADDRESS:PATTERN "X0X10X10"
:TRIGGER:I2C:ADDRESS:ADDRESS:PATTERN? -> :TRIGGER:I2C:ADDRESS:ADDRESS:PATTERN "X0X10X10"

:TRIGger:I2C:ADDRESS:DATA<x>?

Function Queries all settings related to each address pattern setting for the Adrs&Data trigger.

Syntax :TRIGger:I2C:ADDRESS:DATA<x>? <x>=1, 2

Example :TRIGGER:I2C:ADDRESS:DATA1? ->
:TRIGGER:I2C:ADDRESS:DATA1:MODE 0;
PATTERN 1 "10X10X10";
CONDITION FALSE

:TRIGger:I2C:ADDRESS:DATA<x>:CONDition

Function Sets the condition of each data pattern for the Adrs&Data trigger or queries the current setting.

Syntax :TRIGger:I2C:ADDRESS:DATA<x>:CONDition {TRUE|FALSE}
:TRIGger:I2C:ADDRESS:DATA<x>:CONDition? <x>=1, 2

Example :TRIGGER:I2C:ADDRESS:DATA1:CONDITION TRUE:
TRIGGER:I2C:ADDRESS:DATA1:CONDITION? -> :TRIGGER:I2C:ADDRESS:DATA1:CONDITION TRUE

:TRIGger:I2C:ADDRESS:DATA<x>:DBYTE

Function Sets the number of bytes of the data pattern (Data2 Pattern) for the Adrs&Data trigger or queries the current setting.

Syntax :TRIGger:I2C:ADDRESS:DATA<x>:DBYTE {<NRf>}
:TRIGger:I2C:ADDRESS:DATA<x>:DBYTE? <NRf>=1, 2
<x>=2

Example :TRIGGER:I2C:ADDRESS:DATA2:DBYTE 2
:TRIGGER:I2C:ADDRESS:DATA2:DBYTE? -> :TRIGGER:I2C:ADDRESS:DATA2:DBYTE 2

:TRIGger:I2C:ADDRESS:DATA<x>:HEXA<y>

Function Sets each data pattern for the Adrs&Data trigger in hexadecimal.

Syntax :TRIGger:I2C:ADDRESS:DATA<x>:HEXA<y> {<String>}
:TRIGger:I2C:ADDRESS:DATA<x>:HEXA<y>? <String>=2 characters by combining '0' to 'F' and 'X'
<x>=1, 2
<y>=1, 2 (except when <x>=1, <y>=1 only)

Example :TRIGGER:I2C:ADDRESS:DATA1:HEXA1 "2B"

:TRIGger:I2C:ADDRESS:DATA<x>:MODE

Function Enables or disables each data pattern for the Adrs&Data trigger or queries the current setting.

Syntax :TRIGger:I2C:ADDRESS:DATA<x>:MODE {<Boolean>}
:TRIGger:I2C:ADDRESS:DATA<x>:MODE? <x>=1, 2

Example :TRIGGER:I2C:ADDRESS:DATA1:MODE ON
:TRIGGER:I2C:ADDRESS:DATA1:MODE? ->
:TRIGGER:I2C:ADDRESS:DATA1:MODE 1

:TRIGger:I2C:ADDRESS:DATA<x>:PATtern<y>

Function Sets each data pattern for the Adrs&Data trigger in binary or queries the current setting.

Syntax :TRIGger:I2C:ADDRESS:DATA<x>:PATtern<y> {<String>}
:TRIGger:I2C:ADDRESS:DATA<x>:PATtern<y>? <String>=8 characters by combining '0,' '1,' and 'X'
<x>=1, 2
<y>=1, 2 (except when <x>=1, <y>=1 only)

Example :TRIGGER:I2C:ADDRESS:DATA1:PATTERN1 "10X10X10"
:TRIGGER:I2C:ADDRESS:DATA1:PATTERN1? -> :TRIGGER:I2C:ADDRESS:DATA1:PATTERN1 "10X10X10"

:TRIGger:I2C:BCOunt

Function Sets the byte count for the Adrs&Data trigger or queries the current setting.

Syntax `:TRIGger:I2C:BCOunt {X|<Nrf>}`
`:TRIGger:I2C:BCOunt?`
`<Nrf>=0 to 9999`

Example `:TRIGGER:I2C:BCOUNT 1`
`:TRIGGER:I2C:BCOUNT? ->`
`:TRIGGER:I2C:BCOUNT 1`

:TRIGger:I2C:COMBination

Function Sets the combination trigger or queries the current setting.

Syntax `:TRIGger:I2C:COMBination {ONLY|ONPattern|APATtern}`
`:TRIGger:I2C:COMBination?`

Example `:TRIGGER:I2C:COMBINATION ONLY`
`:TRIGGER:I2C:COMBINATION? ->`
`:TRIGGER:I2C:COMBINATION ONLY`

:TRIGger:I2C:IREStart

Function Sets whether to ignore the restart condition (YES/NO) of the trigger or queries the current setting.

Syntax `:TRIGger:I2C:IREStart {YES|NO}`
`:TRIGger:I2C:IREStart?`

Example `:TRIGGER:I2C:IRESTART YES`
`:TRIGGER:I2C:IRESTART? ->`
`:TRIGGER:I2C:IRESTART YES`

:TRIGger:I2C:IUNexpected

Function Sets whether to ignore the start/stop conditions that do not conform to the protocol (YES/NO) of the trigger or queries the current setting.

Syntax `:TRIGger:I2C:IUNexpected {YES|NO}`
`:TRIGger:I2C:IUNexpected?`

Example `:TRIGGER:I2C:IUNEXPECTED YES`
`:TRIGGER:I2C:IUNEXPECTED? ->`
`:TRIGGER:I2C:IUNEXPECTED YES`

:TRIGger:I2C:PATtern?

Function Queries all settings related to each channel pattern setting of the combination trigger.

Syntax `:TRIGger:I2C:PATtern?`

Example `:TRIGGER:I2C:PATTERN? ->`
`:TRIGGER:I2C:PATTERN:CLOCK NONE;`
`CHANNEL3 DONTCARE;`
`CHANNEL4 DONTCARE;CONDITION ENTER`

:TRIGger:I2C:PATtern:CHANnel<x>

Function Sets the condition (pattern or slope) of each channel of the combination trigger or queries the current setting.

Syntax `:TRIGger:I2C:PATtern:CHANnel<x>`
`{HIGH|LOW|DONTcare|RISE|FALL}`
`:TRIGger:I2C:PATtern:CHANnel<x>?`
`<x>=3 to 4`

Example `:TRIGGER:I2C:PATTERN:CHANNEL3 HIGH`
`:TRIGGER:I2C:PATTERN:CHANNEL3? ->`
`:TRIGGER:I2C:PATTERN:CHANNEL3 HIGH`

Description When set to
`“:TRIGger:I2C:PATtern:CLOCK NONE”`, select from {HIGH|LOW|DONTcare}. For all other cases, select from {RISE|FALL}.

:TRIGger:I2C:PATtern:CLOCK

Function Sets the clock channel of the combination trigger or queries the current setting.

Syntax `:TRIGger:I2C:PATtern:CLOCK`
`{NONE|<Nrf>}`
`:TRIGger:I2C:PATtern:CLOCK?`
`<Nrf>=3 to 4`

Example `:TRIGGER:I2C:PATTERN:CLOCK 3`
`:TRIGGER:I2C:PATTERN:CLOCK? ->`
`:TRIGGER:I2C:PATTERN:CLOCK 3`

Description You can set or query the clock channel only when `“:TRIGger:I2C:COMBination”` is `APATtern`.

:TRIGger:I2C:PATtern:CONDition

Function Sets the pattern condition of the combination trigger or queries the current setting.

Syntax `:TRIGger:I2C:PATtern:CONDition`
`{ENTER|EXIT|TRUE|FALSE}`
`:TRIGger:I2C:PATtern:CONDition?`

Example `:TRIGGER:I2C:PATTERN:CONDITION ENTER`
`:TRIGGER:I2C:PATTERN:CONDITION? ->`
`:TRIGGER:I2C:PATTERN:CONDITION ENTER`

Description When `“TRIGger:I2C:COMBination”` is set to `“ONPattern,”` select from {TRUE|FALSE}. When `“TRIGger:I2C:COMBination”` is set to `“APATtern”` and `“TRIGger:I2C:PATtern:CLOCK”` is set to `“NONE,”` select from {ENTER|EXIT}. For all other conditions, the setting is invalid.

:TRIGger:I2C:TYPE

Function Sets the I²C trigger type or queries the current setting.

Syntax `:TRIGger:I2C:TYPE {ADDRESS|NACK}`
`:TRIGger:I2C:TYPE?`

Example `:TRIGGER:I2C:TYPE ADDRESS`
`:TRIGGER:I2C:TYPE? ->`
`:TRIGGER:I2C:TYPE ADDRESS`

1.8 Communication Commands

:TRIGger:TYPE

Function Sets the trigger type or queries the current setting.

Syntax :TRIGger:TYPE {ABN|ADB|PATTern|
WIDTh|OR|TV|SIMPlE|I2CBUS}
:TRIGger:TYPE?

Example :TRIGGER:TYPE I2CBUS
:TRIGGER:TYPE? ->
:TRIGGER:TYPE I2CBUS

2.1 Overview of the SPI Bus Signal Analysis Function

About the SPI Bus Signal Analysis Function

The SPI (Serial Peripheral Interface) Bus is a synchronized serial bus that is widely used for inter-IC communications and data communications.

By using this function, you will be able to analyze data while displaying the SPI Bus signal waveform.

The SPI Bus signal analysis function consists of the following three main functions.

Trigger Function <See page 2-5 for the operating procedure>

Acquires SPI Bus signals by comparing the specified conditions with the master output slave input signal (MOSI)* or master input slave output signal (MISO)* at the byte level (8 bits). MOSI or MISO data is divided into 8 bits from the valid edge of the clock signal (SCK)* immediately after the assertion of the slave select signal (SS)*. If the number of bits is not an integer multiple of 8, data is compared every 8 bits from the first edge, but the last data that is less than 8 bits is not compared.

* On the DL1740E/DL1740EL, the SCK (clock signal), MOSI (master output slave input signal), MISO (master input slave output signal), and SS (slave select signal) are applied to CH1, CH2, CH3, and CH4, respectively.

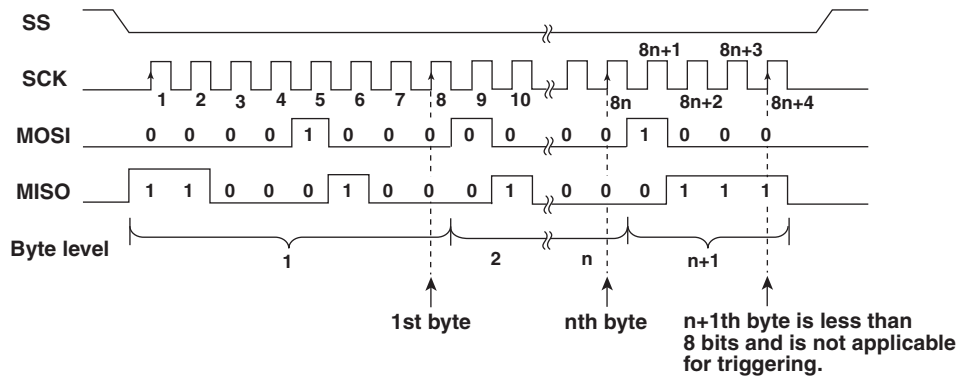

To activate triggers on the DL1740E/DL1740EL, you will set pattern A/B and/or byte count. Triggers can be activated in various ways such as when the MOSI data pattern matches pattern A; the specified byte count after the MOSI data pattern matches pattern A; or when the MISO data pattern matches pattern B after the specified byte count elapses after the MOSI data pattern matches pattern A.

To activate a trigger the specified byte count after MOSI matches Pattern A (Number of bytes of Pattern A: 4, byte count: 3)

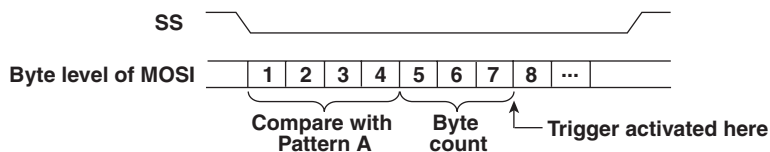

3.1 Overview of the SPI Bus Signal Analysis Function

Analysis Function <See page 2-19 for the operating procedure>

When the SPI Bus signal acquisition is stopped, the signal data stored to the acquisition memory (including the data stored as history waveforms) can be analyzed. Analysis is performed at the byte level (8 bits) by synchronizing to the clock signal.

When the analysis is executed, an analysis result list is displayed on the lower section of the screen. The analysis data can be displayed in hexadecimal or binary. The analysis data and the SPI Bus signal can be displayed simultaneously.

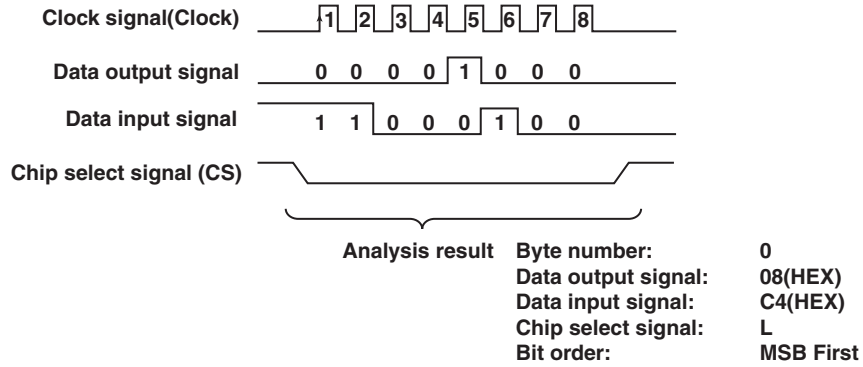

Note

The notation of the SPI Bus signal on the DL7440/DL7480 differs between the trigger condition setup menu and the analysis condition setup menu as follows:

Channel	Notation on the trigger condition setup menu	Notation on the analysis condition setup menu
CH1	SCK (clock signal)	Clock (clock signal)
CH2	MOSI (master output slave input signal)	Data1 (data input/output signal)
CH3	MISO (master input slave output signal)	Data2 (data input/output signal)
CH4	SS (slave select signal)	CS (chip select signal)

Search Function <See page 2-23 for the operating procedure>

Data that matches a specified determination pattern can be searched from the analysis data (forward search and backward search), and the data that is found can be displayed expanded on the zoom display. You can set the determination pattern in hexadecimal or binary and the data length in the range of 1 to 8 bytes. You can also search indefinite data.

2.2 Flow of Operation

The figure below provides an overview of the flow of operations when using the SPI Bus signal analysis function. For details about specific items, see the referenced pages in this manual or the respective sections in the *DL1720E/DL1740E/DL1740EL User's Manual (IM701730-01E)*.

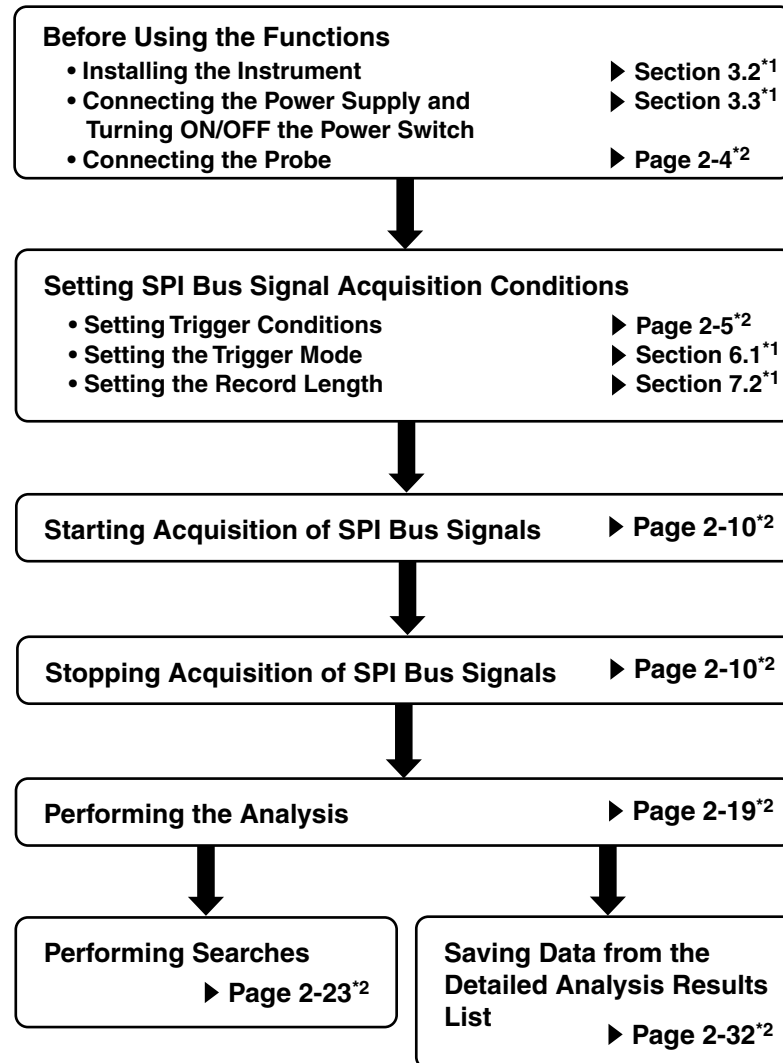

*1. Indicates reference sections from the DL1720E/DL1740E/DL1740EL user's manual (IM701730-01E).

*2. Indicates reference pages from this manual.

2.3 Connecting the Probe

Input Terminals

Connect the probe (or other input cables such as the BNC cable) to any of the input terminals located on the lower section of the front panel. The input impedance is $1\text{ M}\Omega \pm 1.0\%$ and approximately 20 pF or $50\ \Omega \pm 1.0\%$.



CAUTION

- The maximum input voltage for $1\text{-M}\Omega$ input is 400 V (DC + AC_{peak}) or 282 Vrms when the frequency is 1 kHz or less. Applying a voltage exceeding either of these voltages can damage the input section. If the frequency is above 1 kHz , the input section may be damaged even when the voltage is below the values specified above.
- The maximum input voltage for $50\text{-}\Omega$ input is 5 Vrms or 10 Vpeak . Applying a voltage exceeding either of these voltages can damage the input section.

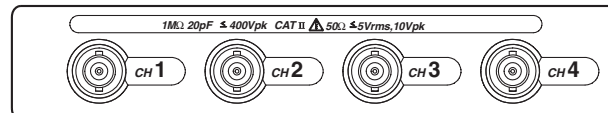

Precautions to Be Taken When Connecting a Probe

- When activating triggers on the SPI Bus signal, connect the signals to the input terminals as follows:
 - CH1: Clock signal (SCK)
 - CH2: Master output slave input signal (MOSI)*
 - CH3: Master input slave output signal (MISO)*
 - CH4: Slave select signal (SS)*
- *
 - When performing analysis, CH2 and CH3 can be connected to MOSI or MISO.
 - During the analysis, the DL1740E/DL1740EL handles the data of the signal connected to CH2 and CH3 as Data1 and Data2, respectively. The slave select signal is displayed as CS on the analysis condition setup menu and can be applied to CH4.
 - To activate triggers on the SPI Bus signal, be sure to apply the slave select signal (SS) to CH4.
- When connecting a probe to the instrument for the first time, perform phase correction of the probe as described in section 2.5, "Compensating the Probe (Phase Correction)" in the *DL1720E/DL1740E/DL1740EL User's Manual (IM701730-01E)*. Failure to do so may result in unstable gain across different frequencies, thereby preventing correct measurement. Calibration must be performed for each channel that is to be connected.
- Note that if the object being measured is directly connected to the instrument without using a probe, correct measurements may not be possible due to the loading effect.

2.4 Setting SPI Bus Signal Acquisition Conditions

The SPI Bus signal is acquired using the conditions of the four SPI bus signals* as trigger conditions.

* SCK (clock signal), MOSI (master output slave input signal), MISO (master input slave output signal), and SS (slave select signal)

Procedure

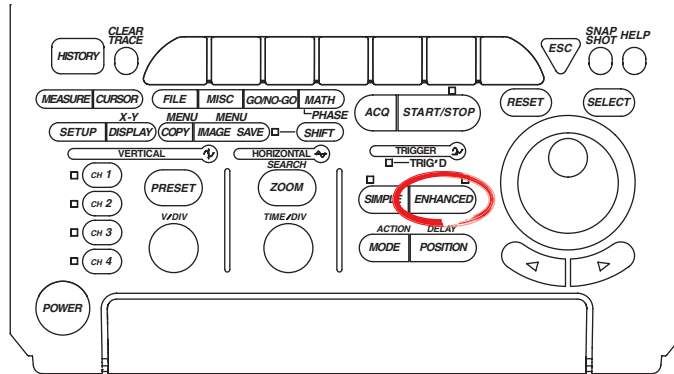

- To exit the menu during operation, press **ESC** located above the soft keys.
- In the procedural explanation below, the term *jog shuttle & SELECT* refers to the operation of selecting/setting items and entering values using the **jog shuttle** and **SELECT** and **RESET** keys. For details on this operation, see sections 4.1 or 4.2 in the DL1720E/DL1740E/DL1740EL User's Manual.
- For a description of the operation using a USB keyboard or a USB mouse, see section 4.3 in the DL1720E/DL1740E/DL1740EL User's Manual.

1. Press **ENHANCED**. The ENHANCED menu appears.
2. Press the **Type** soft key. The Type menu appears.

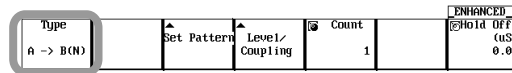

3. Press the **SPI Bus** soft key.

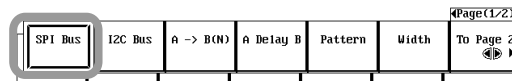

Setting the Trigger Conditions of the SPI Bus Signal

4. Press the **SPI Setup** soft key. The SPI Setup dialog box opens.

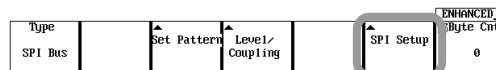

- **Setting the Notation System of Pattern A and Pattern B**

5. Use **jog shuttle & SELECT** to set the notation system used to set Pattern A and Pattern B to Hex or Bin (Pattern Format box). The format in the A Pattern and B Pattern boxes changes accordingly.

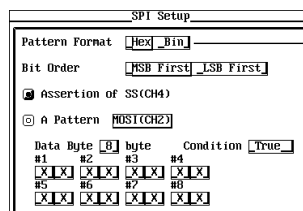

Set the notation system of Pattern A and Pattern B to Hex or Bin.

2.4 Setting SPI Bus Signal Acquisition Conditions

- **Selecting the Read Direction of the I/O Data Bits**

6. Use **jog shuttle & SELECT** to set the read direction of the I/O data bits to MSB First or LSB First (Bit Order box).



- **Selecting the Items Used as a Trigger Condition**

7. Use **job shuttle & SELECT** to select whether Assertion of SS (CH4), A Pattern, Byte Count, and B Pattern are used as trigger conditions. If A Pattern is turned ON, proceed to step 8. To set the Byte Count, proceed to step 11. If B Pattern is turned ON, proceed to step 12.
 - Highlighting of the mark to the left of each item indicates that it is used as a trigger condition.
 - Assertion of SS (CH4) and Byte Count items are always used as trigger conditions (the mark to the left is always highlighted).
 - If you do not wish to use byte count as a trigger condition, set Byte Count to 0 (see step 11).

When Using Pattern A as a Trigger Condition

8. Use **jog shuttle & SELECT** to set the data length of the determination pattern to be specified from 1 to 8 bytes (Data Byte box). The number of bytes displayed in the A Pattern box is set to the number of bytes that matches the selected result.
9. Use **jog shuttle & SELECT** to set the determination pattern for each byte in hexadecimal or binary (A Pattern box). When determination is not to be performed, select X.
10. Use **jog shuttle & SELECT** to set the condition of Pattern A to True or False (Condition box).

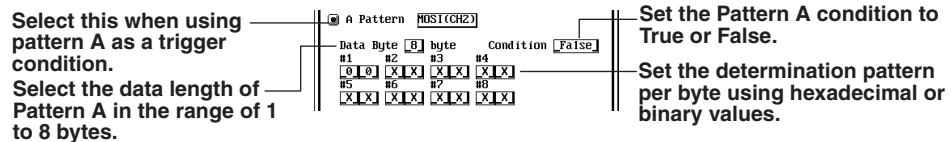

When Setting the Byte Count

11. Use **jog shuttle & SELECT** to set the byte count in the range of 0 to 1000 bytes (Byte Count box).
 - If you do not wish to use byte count as a trigger condition, set the value to 0.
 - You can also set the byte count using the soft key that appears at the right of the ENHANCED menu (a menu that appears when you carry out steps 1 to 3 on the previous page).

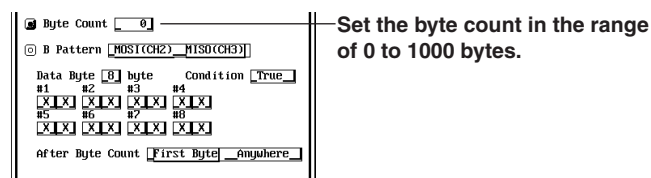

When Using Pattern B as a Trigger Condition

12. Use **jog shuttle & SELECT** to set the pattern MOSI (CH2) or MISO (CH3) to be assigned to Pattern B.
13. Use **jog shuttle & SELECT** to set the data length of the determination pattern to be specified from 1 to 8 bytes (Data Byte box). The number of bytes displayed in the B Pattern box is set to the number of bytes that matches the selected result.
14. Use **jog shuttle & SELECT** to set the determination pattern for each byte in hexadecimal or binary (B Pattern box). When determination is not to be performed, select X.
15. Use **jog shuttle & SELECT** to set the condition of Pattern B to True or False (Condition box).
16. Use **jog shuttle & SELECT** to select whether to compare the Pattern B to the pattern immediately after the byte count (First Byte) or continue to compare until SS is negated (Anywhere) (After Byte Count box).

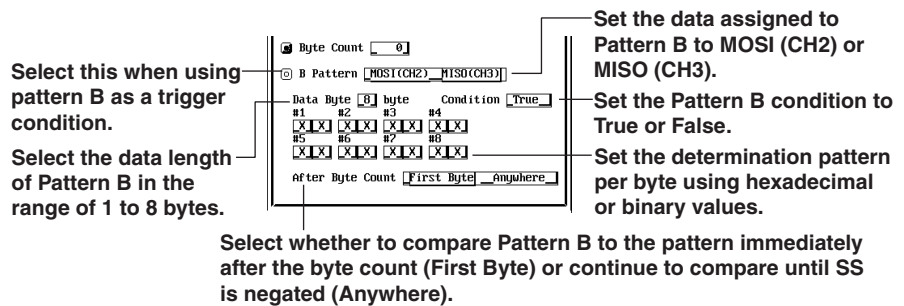

17. Press **ESC**. The SPI Setup dialog box closes.

Setting the Assignment Conditions of the SPI Bus Signal

18. Press the **Set Pattern** soft key. The Set Pattern dialog box displays the assignment conditions of the SPI Bus signals of CH1 to CH4.
19. Use **jog shuttle & SELECT** to set the slope of the CH1 (SCK) edge to \uparrow (rising edge) or \downarrow (falling edge).
20. Use **jog shuttle & SELECT** to set the CH4 (SS) enable state to H (high) or L (low).

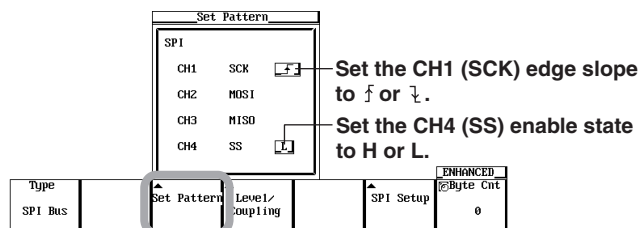

21. Press the **ESC**. The Set Pattern dialog box closes.

2.4 Setting SPI Bus Signal Acquisition Conditions

Setting the Trigger Level, Trigger Coupling, Etc.

22. Press the **Level/Coupling** soft key. The Level/Coupling dialog box opens.
23. Set the trigger level, trigger hysteresis, trigger coupling, and HF rejection of each channel. For the setup procedure, see steps 9 to 13 on page 6-15 in the *DL1720E/DL1740E/DL1740EL User's Manual (IM701730-01E)*.

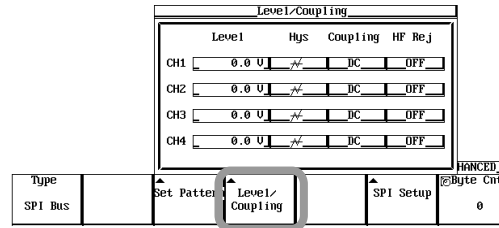

24. Press **ESC**. The Level/Coupling dialog box closes.

Setting the Trigger Mode

25. Set the trigger mode according to the procedures given in section 6.1, "Setting the Trigger Mode" in the *DL1720E/DL1740E/DL1740EL User's Manual (IM701730-01E)*.

Setting the Record Length

26. Set the record length according to the procedures given in section 7.2, "Setting the Record Length" in the *DL1720E/DL1740E/DL1740EL User's Manual (IM701730-01E)*.

Starting/Stopping the SPI Bus Signal Acquisition

27. Press **START/STOP** to start the SPI Bus signal acquisition. Triggers are activated on the specified trigger conditions.
To proceed to the analysis, press **START/STOP** to stop the SPI Bus signal acquisition.

Explanation**Setting the Trigger Conditions of the SPI Bus Signal: SPI Setup**

You can set the following conditions.

- **Pattern Format**

Select the format for Pattern A and Pattern B from the following:

Hex	Hexadecimal
Bin	Binary

- **Bit Order**

You can select the bit order of Pattern A and Pattern B according to the signal flow of the input/output data. When setting the pattern in binary, set the data in the order of the flow regardless of the bit order setting. When setting the pattern in hexadecimal, enter the pattern according to the bit order setting, separated every four bits in the order of the flow.

MSB First	Select this when the I/O data signal is flowing MSB first.
LSB First	Select this when the I/O data signal is flowing LSB first.

Note

The bit order setting is connected with the setting in the Analyze Setup dialog box (see page 2-21).

- **Type of the SPI Bus Signal Trigger Condition**

You can select the type of the SPI Bus signal trigger condition from the four types listed below. You can use the AND condition to select multiple types at the same time. However, Assertion of SS and Byte Count are always selected.

Assertion of SS(CH4)

The trigger function of the SPI Bus signal counts the valid edges of SCK (CH1) after SS (CH4) is asserted and divides MOSI (CH2) or MISO (CH3) into bytes. Therefore, Assertion of SS (CH4) is always selected.

A Pattern

Set the bit pattern used to compare with the command or address sent from the master to the slave. The pattern is compared with the bit pattern of MOSI (CH2) that is present immediately after SS (CH4) is asserted.

Byte Count

You can activate a trigger after the specified number of bytes elapses after the assertion of SS (CH4) (after the condition of Pattern A is met when Pattern A is selected). You can set the byte count in the range of 0 to 1000. The Byte Count item is always selected. If you do not wish to use Byte Count as a trigger condition, set the value to 0.

B Pattern

Set the bit pattern used to compare with the data written by the master to the slave or the data read by the master from the slave. You can select write data (MOSI) or read data (MISO) to be compared. The pattern is compared with the bit pattern the byte count after the assertion of SS (CH4).

Note

If multiple types are combined, the trigger point is set to the trigger point of the type that appeared last in the time sequence.

2.4 Setting SPI Bus Signal Acquisition Conditions

- **When the Type of SPI Bus Signal Trigger Condition Is Set to A Pattern**

Data Byte

Select the data length of A Pattern in the range of 1 to 8 bytes.

Bit Pattern

You can set the bit pattern. When Pattern Format is set to Hex (hexadecimal), you can enter X, 0 to 9, or A to F in units of 4 bits. When Pattern Format is set to Bin (binary), you can enter X, 0, or 1.

If there is at least one “X” bit in a group of four bits in the binary display, the corresponding hexadecimal display will show an “\$”.

Condition

You can select from the following:

True	A trigger is activated when A Pattern is met.
False	A trigger is activated when A Pattern is not met.

- **When the Type of SPI Bus Signal Trigger Condition Is Set to B Pattern**

Selecting the data

Select the data to be used for B Pattern from the following:

MOSI (CH2)	Data written by the master to the slave
MISO (CH3)	Data read by the master from the slave

Data Byte

Select the data length of B Pattern in the range of 1 to 8 bytes.

Bit Pattern

You can set the bit pattern. When Pattern Format is set to Hex (hexadecimal), you can enter X, 0 to 9, or A to F in units of 4 bits. When Pattern Format is set to Bin (binary), you can enter X, 0, or 1.

If there is at least one “X” bit in a group of four bits in the binary display, the corresponding hexadecimal display will show an “\$”.

Condition

You can select from the following:

True	A trigger is activated when B Pattern is met.
False	A trigger is activated when B Pattern is not met.

After Byte Count



You can select from the following:

First Byte	Compares Pattern B to the bit pattern the byte count after the assertion of SS.
Anywhere	Continues to compare Pattern B until SS (CH4) is negated.

Setting the Assignment Conditions of the SPI Bus Signal

- **Slope of CH1 (SCK) Edge**

Select the slope from the following:

	Rising edge
	Falling edge

- **Enable State of CH4 (SS)**

Select the state from the following:

H	Status when the SS signal is above the trigger level. A trigger is activated when the SS signal is high.
L	Status when the SS signal is below the trigger level. A trigger is activated when the SS signal is low.

Setting the Trigger Level, Trigger Coupling, Etc.: Level/Coupling

Set the trigger level, hysteresis, trigger coupling, and HF rejection of each channel.

For details on the trigger level, hysteresis, trigger coupling, and HF rejection, see page 6-17 in section 6.8, “Setting the A->B(N) Trigger (ENHANCED)” in the *DL1720E/DL1740E/DL1740EL User’s Manual (IM701730-01E)*.

Setting the Trigger Mode

Set the conditions for updating the displayed waveforms as a trigger mode. There are five trigger modes: auto mode, auto level mode, normal mode, single mode, and single (N) mode.

For details on the trigger modes, see section 6.1, “Selecting the Trigger Mode” in the *DL1720E/DL1740E/DL1740EL User’s Manual (IM701730-01E)*.

Setting the Record Length

The record length sets the amount of data to be written into the acquisition memory. The selectable maximum record length varies depending on the model.

DL1740E	1 k, 10 k, 50 k, 100 k, 250 k, 500 k, 1 M (, 2 M)*
DL1740EL	1 k, 10 k, 50 k, 100 k, 250 k, 500 k, 1 M, 2 M, 4 M (, 8 M)*

* The value inside the parentheses is selectable only when interleave mode is ON.

For details on the record length, see section 7.2, “Setting the Record Length” in the *DL1720E/DL1740E/DL1740EL User’s Manual (IM701730-01E)*. For details on interleave mode, see section 7.3, “Using Interleave Mode.”

Starting/Stopping the SPI Bus Signal Acquisition

When you start the SPI Bus signal acquisition, triggers are activated on the specified trigger conditions.

To proceed to the analysis, you stop the SPI Bus signal acquisition.

Examples of SPI Bus Signal Trigger Conditions

The trigger point is set to the position below depending on the SCK edge slope setting (see page 2-7).

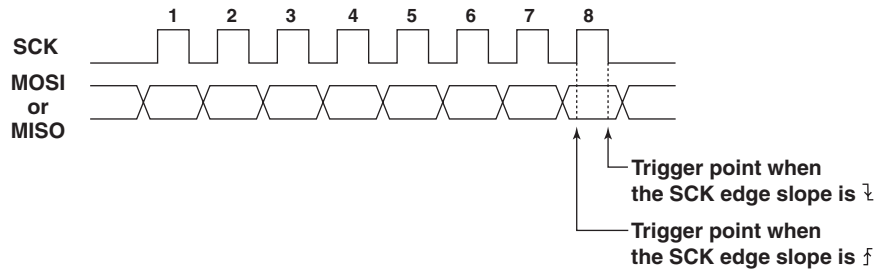

This section will indicate the data sequence at the byte level in hexadecimal and indicate the position where the trigger will occur.

The shaded section is the figure indicates the byte pattern (sequence) that is compared.

Slave Select Assert Trigger

- **Trigger Condition**

SS: L
 A Pattern (MOSI): Not applicable
 B Pattern: Not applicable

<Byte Count=0>

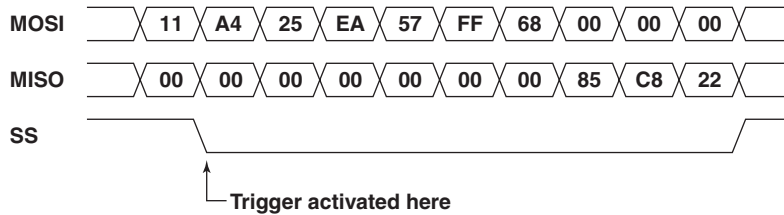

<Byte Count=3>

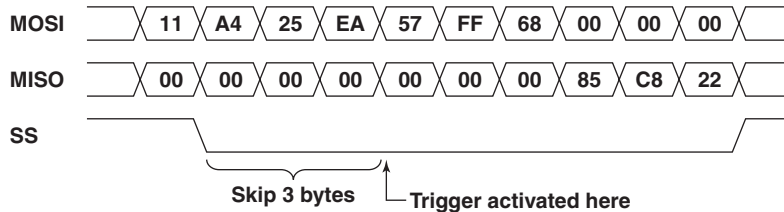

Activate a Trigger Only on Pattern A

- **Trigger Condition**

SS: L
 A Pattern (MOSI): A4 25
 Data Byte: 2
 Condition: True
 B Pattern: Not applicable

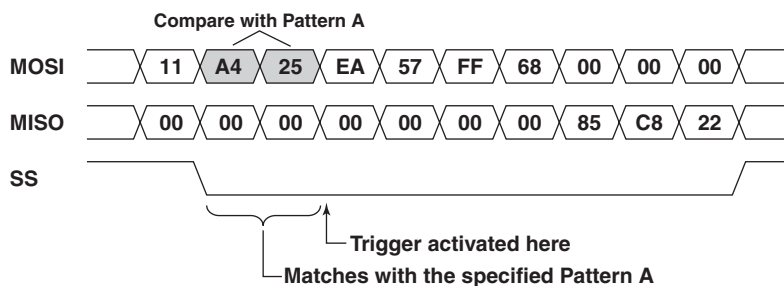

Combination of Pattern A and Byte Count Trigger

• **Trigger Condition**

SS: L
 A Pattern (MOSI): A4 25
 Data Byte: 2
 Condition: True
 Byte Count: 3
 B Pattern: Not applicable

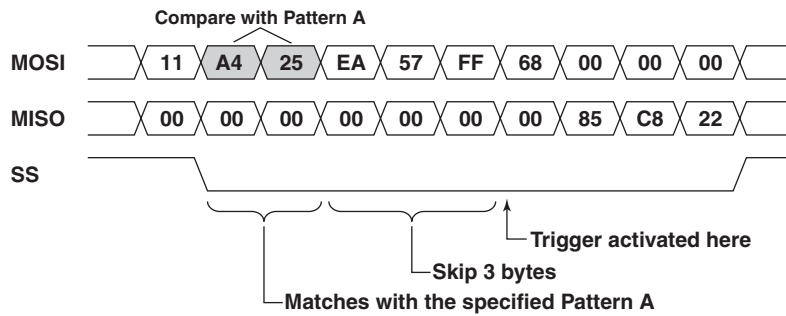

Activate a Trigger Only on Pattern B (MOSI)

• **Trigger Condition**

SS: L
 A Pattern (MOSI): Not applicable
 B Pattern (MOSI): A4 25
 Data Byte: 2
 Condition: True

<After Byte Count=First Byte>

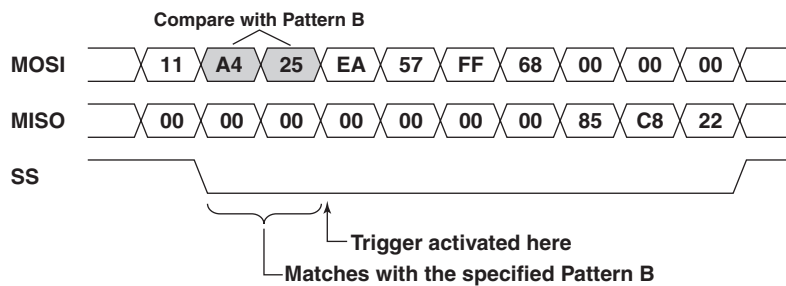

<After Byte Count=Anywhere>

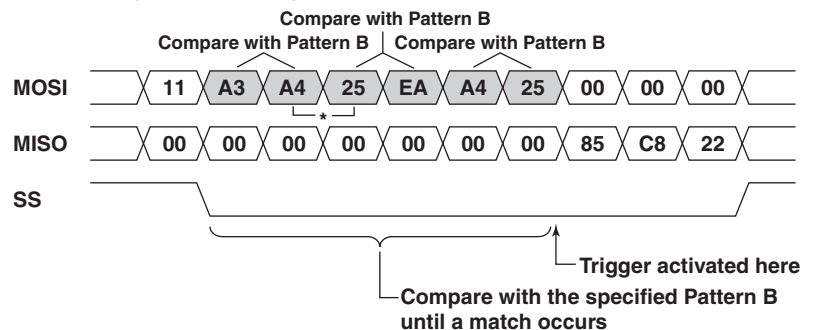

* Trigger does not activate on "A4" and "25", because the comparison is made on 2 bytes.

2.4 Setting SPI Bus Signal Acquisition Conditions

Activate a Trigger Only on Pattern B (MISO)

- Trigger Condition

SS: L
 A Pattern (MOSI): Not applicable
 B Pattern (MISO): See below.
 Data Byte: 2
 Condition: True

<B Pattern (MISO): 00 00, After Byte Count=First Byte>

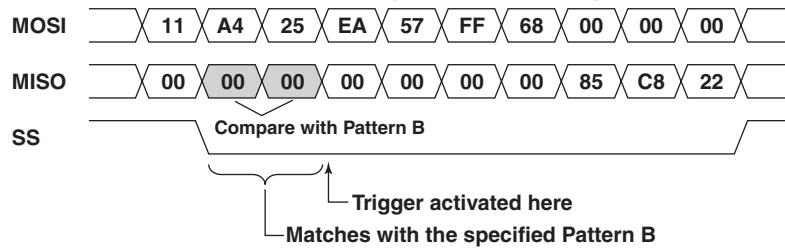

<B Pattern (MISO): 85 C8, After Byte Count=Anywhere>

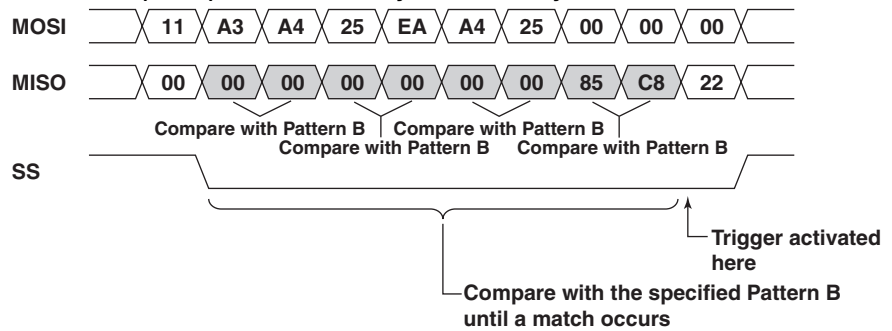

Combination of Pattern A and Pattern B (MOSI)

• **Trigger Condition**

SS: L
 A Pattern (MOSI): A4 25
 Data Byte: 2
 Condition: True
 B Pattern (MOSI): See below.
 Data Byte: 2
 Condition: True

<B Pattern (MOSI):EA 57, After Byte Count=First Byte>

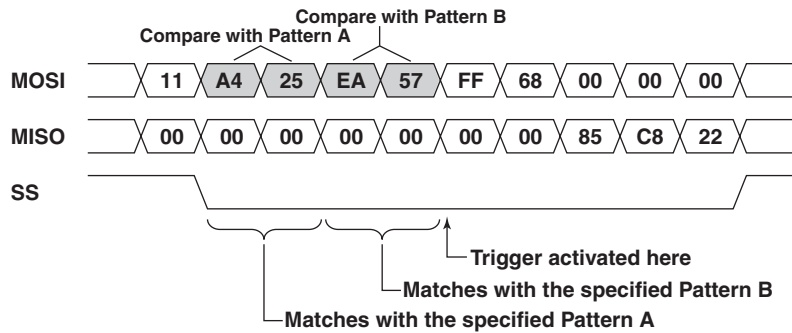

<B Pattern (MOSI): FF 68, After Byte Count=Anywhere>

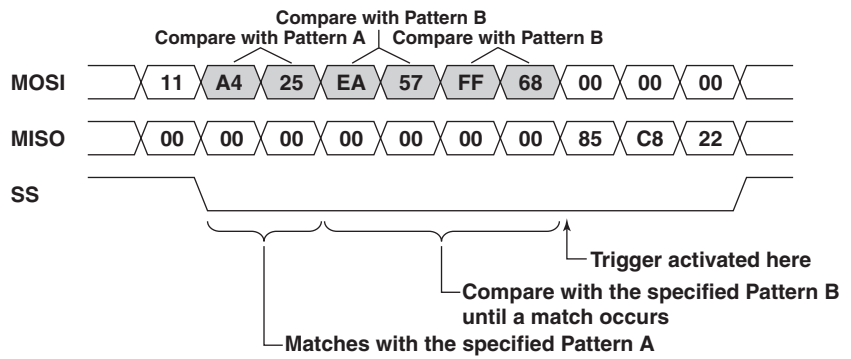

Combination of Pattern A and Pattern B (MISO)

• **Trigger Condition**

- SS: L
- A Pattern (MOSI): A4 25
- Data Byte: 2
- Condition: True
- B Pattern (MISO): See below.
- Data Byte: 2
- Condition: True

<B Pattern (MISO): 00 00, After Byte Count=First Byte>

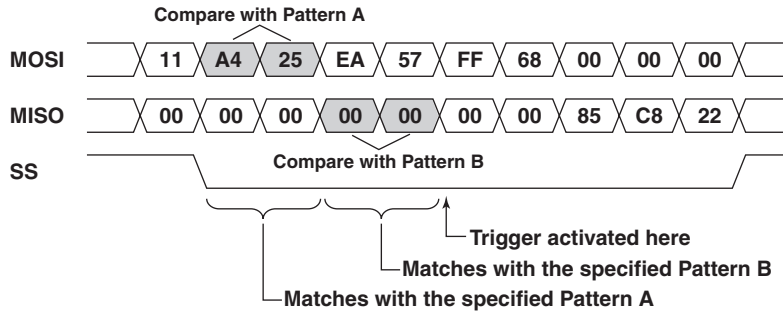

<B Pattern (MISO): 85 C8, After Byte Count=Anywhere>

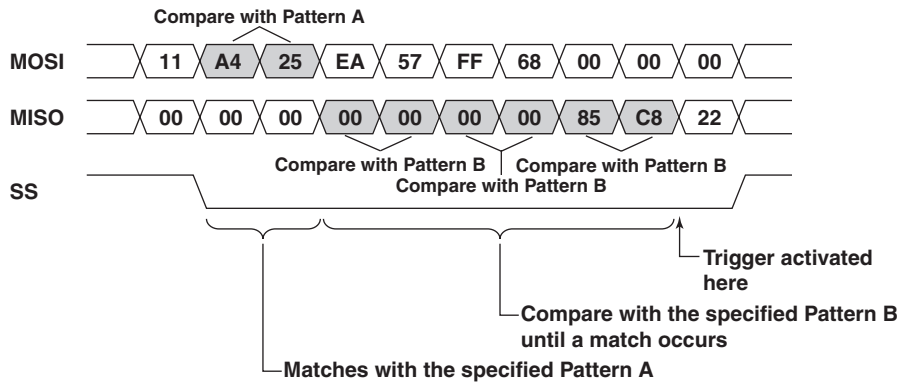

Combination of Pattern A, Byte Count Trigger, and Pattern B (MOSI)

• **Trigger Condition**

- SS: L
- A Pattern (MOSI): A4 25
 - Data Byte: 2
 - Condition: True
- Byte Count: 3
- B Pattern (MOSI): See below.
 - Data Byte: 2
 - Condition: True

<B Pattern (MOSI): 68 00, After Byte Count=First Byte>

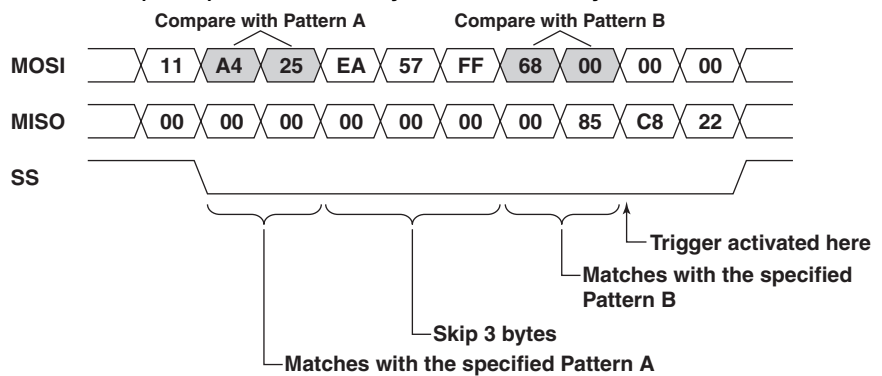

<B Pattern (MOSI): 00 00, After Byte Count=Anywhere>

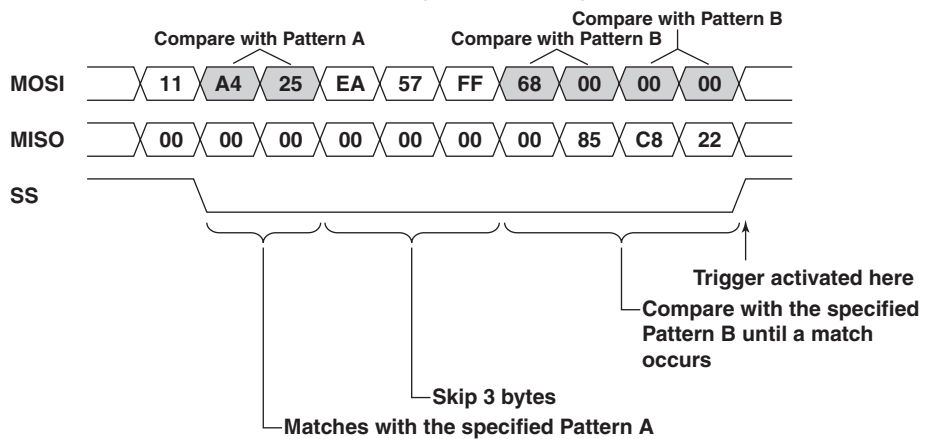

2.4 Setting SPI Bus Signal Acquisition Conditions

Combination of Pattern A, Byte Count Trigger, and Pattern B (MISO)

- **Trigger Condition**

SS: L
 A Pattern (MOSI): A4 25
 Data Byte: 2
 Condition: True
 Byte Count: 3
 B Pattern (MISO): See below.
 Data Byte: 2
 Condition: True

<B Pattern (MISO): 00 85, After Byte Count=First Byte>

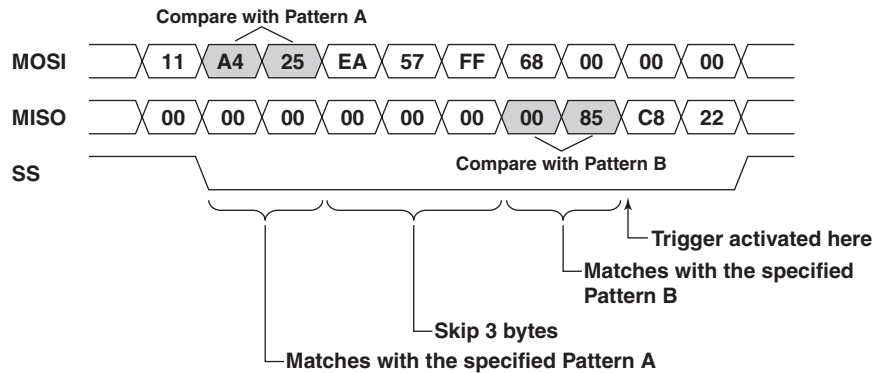

<B Pattern (MISO): C8 22, After Byte Count=Anywhere>

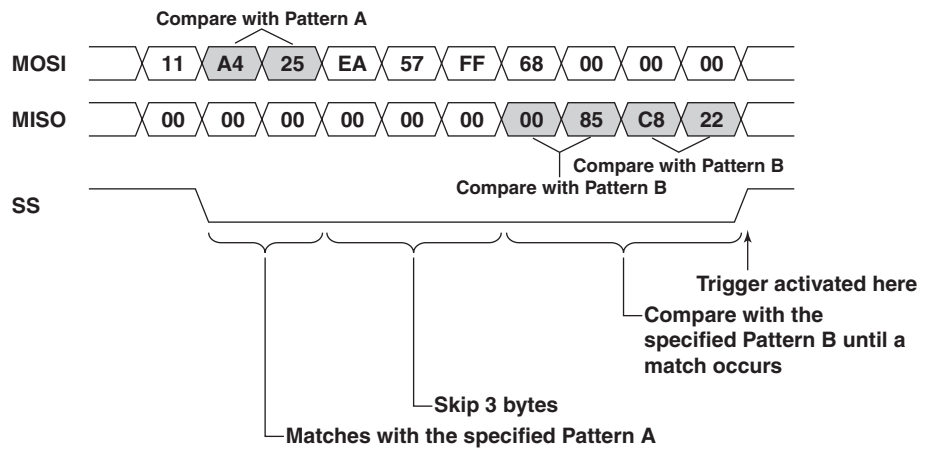

2.5 Analyzing/Searching Data

By setting analysis conditions, the SPI signal data stored to the acquisition memory can be analyzed. You can also search analysis data that matches a data pattern or an indefinite data condition. If analysis data that matches the specified condition is found, the zoom position moves to the corresponding section, and the waveform of the data that is found is displayed in the zoom waveform display frame.

Procedure

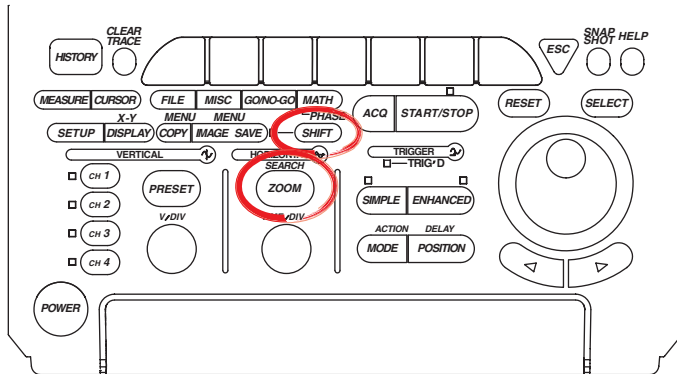

- To exit the menu during operation, press **ESC** located above the soft keys.
- In the procedural explanation below, the term *jog shuttle & SELECT* refers to the operation of selecting/setting items and entering values using the *jog shuttle* and **SELECT** and **RESET** keys. For details on this operation, see sections 4.1 or 4.2 in the DL1720E/DL1740E/DL1740EL User's Manual.
- For a description of the operation using a USB keyboard or a USB mouse, see section 4.3 in the DL1720E/DL1740E/DL1740EL User's Manual.

- Press **SHIFT+ZOOM (SEARCH)**. The SEARCH menu appears.
- Press the **Type** soft key. The Type menu appears.

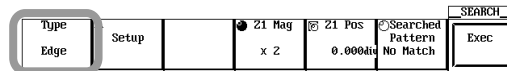

- Press the **SPI Bus** soft key.

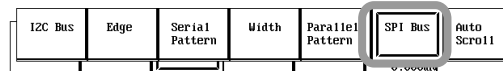

Setting the Analysis Conditions

- Press the **Analyze Setup** soft key. The Analyze Setup dialog box opens.

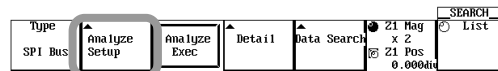

- Setting the Detection Level, Hysteresis, and Slope of the Synchronization Clock Signal (CH1)**

- Use *jog shuttle & SELECT* to set the level for detecting the synchronization clock (Level box).
- Use *jog shuttle & SELECT* to set the hysteresis (width of the level used to detect the synchronization clock) (Hysteresis box).
- Use *jog shuttle & SELECT* to select the slope, rising or falling, for detecting the synchronization clock (Polarity box).

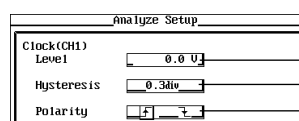

- Set the level for detecting the synchronization clock.
- Set the hysteresis (width of the level used to detect the synchronization clock).
- Select which slope edge, rising or falling, of the synchronization clock is to be detected.

• **Setting the Level for Determining the Status (1 or 0) of the I/O Data**

8. Use **jog shuttle & SELECT** to select whether Data1 (CH2) is to be analyzed (ON/OFF) (Data1 (CH2) box).
 - Data1 (CH2) will be analyzed when the mark to the left is highlighted.
 - When interleave mode is ON, you cannot set Data1 (CH2).
9. Use **jog shuttle & SELECT** to set the level for determining whether the status of Data1 (CH2) is 1 (Thr Upper box).
10. Use **jog shuttle & SELECT** to set the level for determining whether the status of Data1 (CH2) is 0 (Thr Lower box).
 - When the data exceeds the specified level (Thr Upper), it is determined to be 1.
 - When the data is below the specified level (Thr Lower), it is determined to be 0.
 - When the data is between the levels specified by Thr Upper and Thr Lower (including the Thr Upper and Thr Lower values), it is determined to be indefinite data.
11. Repeat steps 8 to 10 to set the level for determining the status of Data2 (CH3).

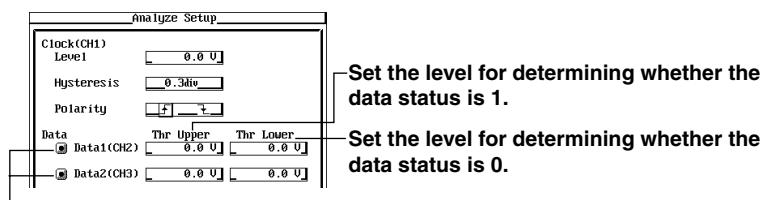

Select whether the data is to be analyzed (ON/OFF).

• **Setting the Chip Select Signal (CS)**

12. Use **jog shuttle & SELECT** to select whether to make CH4 a CS signal (ON/OFF) (each CH box).
 - CH4 is enabled as a CS signal when the mark to the left of CH4 is highlighted.
13. Use **jog shuttle & SELECT** to set the level for determining the status of the CS signal (CH level box on the right).
14. Use **jog shuttle & SELECT** to select the enable status of the CS signal from H, L, or X (Enable State box). I/O data is analyzed when the CS signal matches the selected status.
 - If none of the CS signal is ON, the Enable State box displays “-”.

Select whether CH4 is to be a CS signal (ON/OFF).

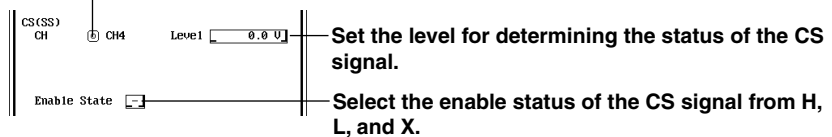

• **Setting the Reference Point of the Analysis**

- 15. Use **jog shuttle & SELECT** to set the reference point to Trigger Position or Manual (Trigger Position or Manual button).

The reference point is set to the one whose mark to the left is highlighted (Trigger Position or Manual).

- 16. If the reference point is set to Manual, use **jog shuttle & SELECT** to set the reference point (Manual box on the right).

When setting the reference point using Manual, you can set the reference point while checking the displayed waveform by enabling translucent display. For a description of the translucent display, see section 8.10 in the *DL1720E/DL1740E/DL1740EL User's Manual (IM701730-01E)*.

Set the reference point to Trigger Position or Manual.

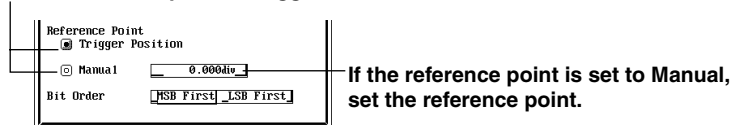

• **Selecting the Read Direction of the I/O Data Bits**

- 17. Use **jog shuttle & SELECT** to set the read direction of the I/O data bits to MSB First or LSB First (Bit Order box).

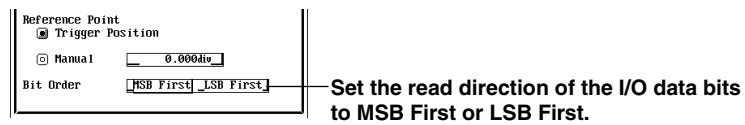

- 18. Press **ESC**. The Analyze Setup dialog box closes.

Executing/Aborting the Analysis

- 19. Press the **Analyze Exec** soft key. The analysis of the I/O data is executed. The words Analyze Exec change to Analyze Abort.

To abort the analysis of the I/O data, press the **Analyze Abort** soft key. The analysis of I/O data is aborted, and the words Analyze Abort change to Analyze Exec.

If indefinite data exists in the analysis data, “*” is attached to the corresponding analysis data.

Analysis number

CS signal status or the name of the CS signal whose

Analysis result list display

Data2 value (hexadecimal)

Data1 value (hexadecimal)

2.5 Analyzing/Searching Data

Displaying the Analysis Data

- **Scrolling the List**

20. Press the **List** soft key.

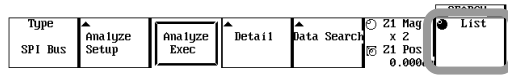

21. Turn the **jog shuttle** to scroll the list left and right.

Up to 20 analysis data points are displayed at once in the order of occurrence. By scrolling the list left and right using the jog shuttle, analysis data beyond 20 data points can be displayed.

- **Setting the Zoom Ratio**

22. Press the **Z1 Mag/Z1 Position** soft key to set the jog shuttle control to Z1 Mag.
23. Turn the **jog shuttle** to set the zoom ratio

- **Setting the Zoom Position**

24. Press the **Z1 Mag/Z1 Position** soft key to set the jog shuttle control to Z1 Position.
25. Turn the **jog shuttle** to set the zoom position. When the center of the zoom box moves to the waveform corresponding to the analysis data on the list, the corresponding analysis data on the list is highlighted.

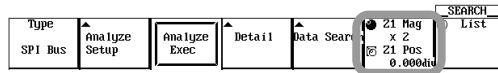

- **Viewing the Details of the Analysis Data**

26. Press the **Detail** soft key. A Detail dialog box opens. The analysis data of the same analysis number that is highlighted in the list in step 25 or step 29 is displayed highlighted.
27. Press the **Hex** or **Bin** soft key to select the notation used to display the analysis data (Data1 and Data2).

If indefinite data exists in the data, "*" is attached to the corresponding analysis data.

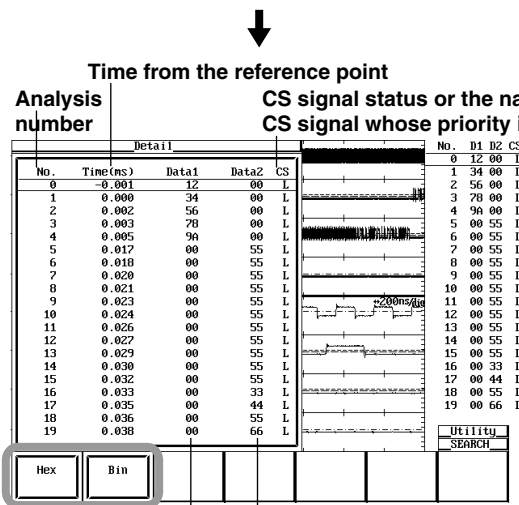

28. Press **ESC**. The Detail dialog box closes.

Note

The detailed analysis list can be saved directly to an external storage medium in ASCII format (.txt extension). For details, see section 2.6, "Saving the Data of the Detailed Analysis List."

Setting the Search Condition

29. Press the **Data Search** soft key. The Data Search menu appears.

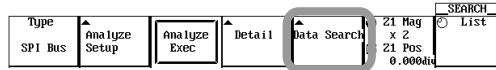

30. Press the **Search Setup** soft key. The Search Setup dialog box opens.

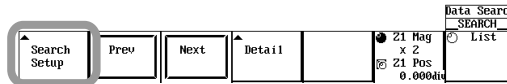

31. Use **jog shuttle & SELECT** to set the search type to Frame Pattern or Indefinite State (Type box).
If you select Indefinite State, proceed to step 33.
32. Use **jog shuttle & SELECT** to set the notation system used to set the determination pattern to Hex or Bin (Pattern Format box). The format in the Data Pattern box changes accordingly.
33. Use **jog shuttle & SELECT** to set the data to be searched to Data1 or Data2 (Source box).
If you selected Indefinite State in step 31, proceed to step 36.
34. Use **jog shuttle & SELECT** to set the data length of the determination pattern to be specified from 1 to 8 bytes (Data Byte box). The number of bytes displayed in the Data Pattern box is set to the number of bytes that matches the selected result.
35. Use **jog shuttle & SELECT** to set the determination pattern for each byte in hexadecimal or binary (Data Pattern box). When determination is not to be performed, select X.
36. Press **ESC**. The Detail dialog box closes.

Set the search type to Frame Pattern or Indefinite State.

(If Indefinite State is selected, select the search target data in the Source box.)

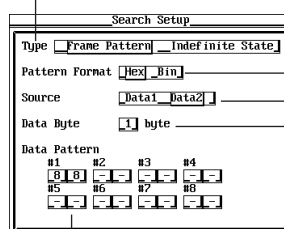

Set the notation system of the data to be searched to Hex or Bin. (The format in the Data Pattern box is set to the format that matches the selected result.)

Set the data to be searched to Data1 or Data2.

Select the search unit (data length) in the range of 1 to 8 bytes. (The number of bytes displayed in the Data Pattern box is set to the number of bytes that matches the selected result.)

Set the determination pattern per byte using hexadecimal or binary values.

2.5 Analyzing/Searching Data

- **Executing the Search Operation**

37. Press the **Next** or **Previous** soft key. The search is executed.

- When the data matches the determination pattern, the corresponding data (data that was found) is highlighted in the analysis data list at the bottom of the screen. The zoom box moves to the position so that the data that was found is at the center, and the zoomed waveform of the data that was found is displayed in the zoom waveform display area.
- Pressing the Next soft key searches the data after the highlighted data (to the right) in the analysis data list at the bottom of the screen.
- Pressing the Previous soft key searches the data before the highlighted data (to the left) in the analysis data list at the bottom of the screen.
- If you selected Indefinite State (indefinite data) in step 31 and execute the search, indefinite data is highlighted.

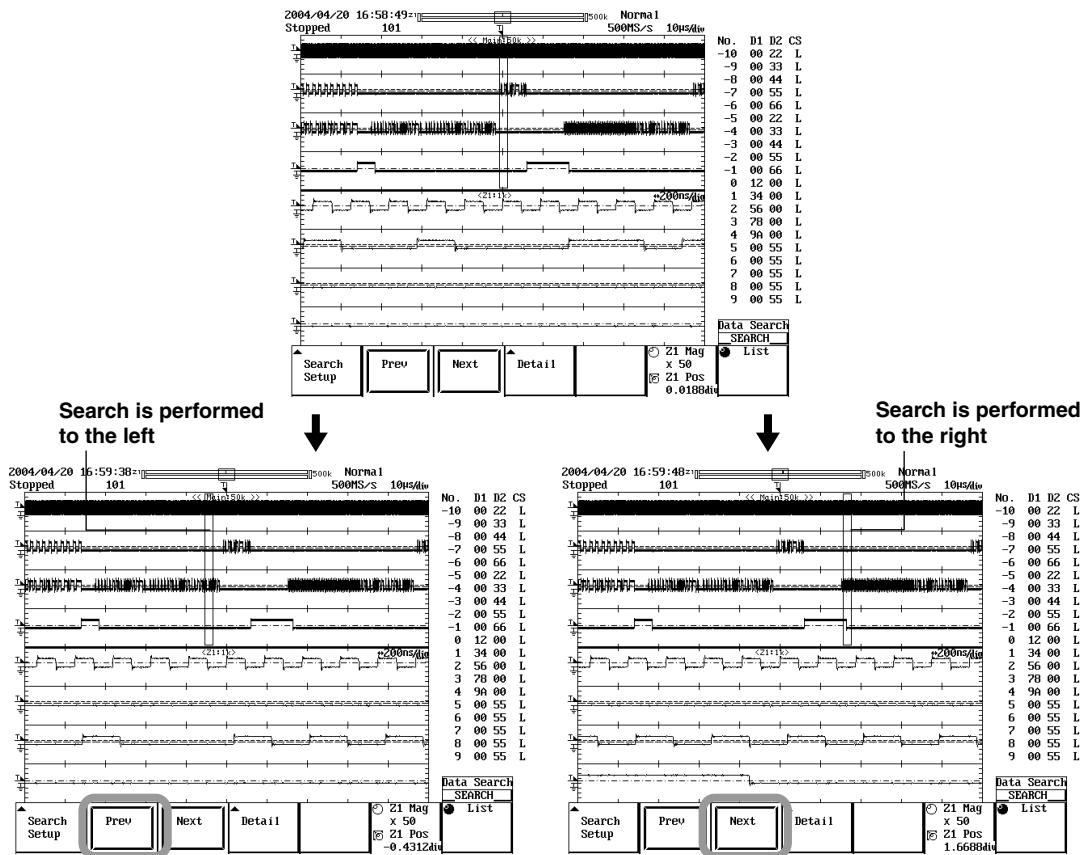

Explanation**Setting the Analysis Conditions: Analyze Setup**

You can set the following conditions.

- **Clock Signal: Clock (CH1)**

Apply the clock signal on the SPI Bus to CH1. The status of the I/O data is determined by synchronizing to the clock signal. You can set the detection level, slope, and hysteresis of the clock signal.

Level

You can set the level for detecting the synchronization clock. The selectable range is eight divisions within the screen. The resolution is 0.01 V/div.



Hysteresis

You can set the hysteresis on the level for detecting the synchronization clock. The selectable range is 0.3 divisions to 4.0 divisions. The resolution is 0.1 divisions.

- When the level of the clock signal changes from below the specified lower limit of hysteresis to above and including the upper limit of hysteresis, it is detected as a synchronization clock.
- When the level of the clock signal changes from above the specified upper limit of hysteresis to below and including the lower limit of hysteresis, it is detected as a synchronization clock.
- For all other cases, it is not detected as a synchronization clock.

Slope: Polarity

You can select which slope edge, rising or falling, of the synchronization clock is to be detected.

	Rising slope
	Falling slope

- **Data to Be Analyzed**

The data that can be analyzed is the I/O data signal on the SPI Bus (Data1 and Data2). The data in the following display range can be analyzed. Apply the Data1 and Data2 signals to CH2 and CH3.

- Waveform data that is displayed when waveform acquisition is stopped.
- History waveform data (waveform selected by Select Record on the History menu).
- Waveform data loaded from a storage medium.

Level Used to Determine the Status of the Data to Be Analyzed: Thr Upper/Thr Lower

You can set the level for determining the status of the data to be analyzed. The selectable range is eight divisions within the screen. The resolution is 0.01 V/div. Thr Upper must be greater than or equal to Thr Lower.

Level for determining 1 (Thr Upper)

You can set the level for determining the status 1. When the data being analyzed exceeds the specified level, it is determined to be 1.

Level for determining 0 (Thr Lower)

You can set the level for determining the status 0. When the data being analyzed is below the specified level, it is determined to be 0.

Between Thr Upper and Thr Lower

The status when the data being analyzed is between the levels specified by Thr Upper and Thr Lower (including the Thr Upper and Thr Lower values) is determined to be indefinite data.

2.5 Analyzing/Searching Data

- **Chip Select Signal: CS (SS)**

You can select the signals of CH4 to CH8 or logic input (A0 to A7 of Pod A) for the CS signal on the SPI Bus. CH5 to CH8 can be used on the DL7480. The logic input is optional.

Level for Determining the Status of the CS Signal: CH Level

When the channel signal is set to be the CS signal, you can set the level for determining the high (H) or low (L) status of the CS signal for each channel. The selectable range is eight divisions within the screen. The resolution is 0.01 V/div.

Use/Not Use as a CS Signal

You can select whether the channel is to be a CS signal (ON/OFF) for each channel CH4 to CH8 or logic input (A0 to A7 of Pod A).

Enable Status of CS Signal: Enable State

You can select the enable status of the CS signal. The setting applies to all CS signals.

H For a channel signal, this is the status when the signal is higher than the level for determining the status of the CS signal. For a logic input signal, this is the status when the signal is 1. The I/O data is analyzed when the CS signal is H.

L For a channel signal, this is the status when the signal is less than the level for determining the status of the CS signal. For a logic input signal, this is the status when the signal is 0. The I/O data is analyzed when the CS signal is L.

X Select this status when not determining the status. All the I/O output data are analyzed. The byte boundary of the data being analyzed is the point where the CS signal changes from high to low or low to high. This status cannot be selected when multiple signals are enabled as CS signals.

– When none of the signals are enabled as a CS signal, this indicator is displayed and cannot be changed. All the I/O output data are analyzed. The data to be analyzed is the I/O data that is divided at the byte level from the analysis reference point (see the next page). Select this status when analyzing the I/O data without using the CS signal.

- **Analysis Reference Point**

You can set the reference point where the analysis is to start. The first analysis data as viewed from this reference point is assigned the analysis number 0. For details on the assignment of the analysis number, see “Analysis Numbers” on the next page.

Trigger Position	Sets the reference point to the trigger position.
Manual	You can set the reference point in the range of ± 5 divisions. The resolution is 10 division \div display record length.

- **Read Direction of the I/O Data Bits: Bit Order**

You can select the read direction of the bits according to the signal flow. When analysis data is displayed in binary, the data is displayed in the order of the flow regardless of the bit order setting. When analysis data is displayed in hexadecimal, the data is displayed according to the setting, separated every four bits in the order of the flow.

MSB First	Select this when the I/O data signal is flowing MSB first.
LSB First	Select this when the I/O data signal is flowing LSB first.



Note

The bit order setting is connected with the setting in the ENHANCED menu in the Analyze Setup dialog box (see page 2-6).

Range That Can Be Analyzed

Up to 80000 bytes of analysis data can be displayed. The displayed result varies depending on the number of bytes analyzed as follows:

- When the total analysis data is less than or equal to 80000 bytes
All points are displayed regardless of the position of the reference point.
- When the total analysis data is greater than 80000 bytes:
The displayed result varies depending on the number of analysis data in the Pre* and Post* sections as follows:

When the Pre section contains 44000 points and the Post section contains 44000 points, 40000 data points in the Pre section and 40000 data points in the Post section are displayed.

When the Pre section contains 8000 points and the Post section contains 80000 points, 8000 data points in the Pre section and 72000 data points in the Post section are displayed.

When the Pre section contains 80000 points and the Post section contains 8000 points, 72000 data points in the Pre section and 8000 data points in the Post section are displayed.

* Pre: Before (left of) the reference point, Post: After (right of) the reference point

Analysis Data List (Analysis Result List)

The following four items are displayed.

- Analysis number
- Data1 value (hexadecimal)
- Data2 value (hexadecimal)
- CS signal status or the name of the CS signal whose priority is high

- **Analysis Numbers**

Up to 80000 bytes can be displayed. Depending on whether the CS signal is ON, the data of analysis number 0 (byte level) is defined as follows: The data points that are newer than the data point of analysis number 0 (to the right on the screen) are assigned numbers 1, 2, 3, and so on as the data points get newer. The data points that are older than the data point of analysis number 0 (to the left on the screen) are assigned numbers -1, -2, -3, and so on as the data points get older.

When None of the CS Signals Is ON

The first detected data after the reference point becomes analysis number 0.

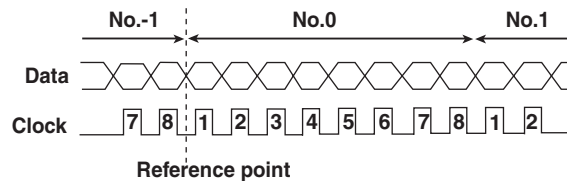

When the CS Signal Is ON

The data containing the reference point becomes analysis number 0. However, if the reference point is between two data points, the first detected data after the reference point becomes analysis number 0.

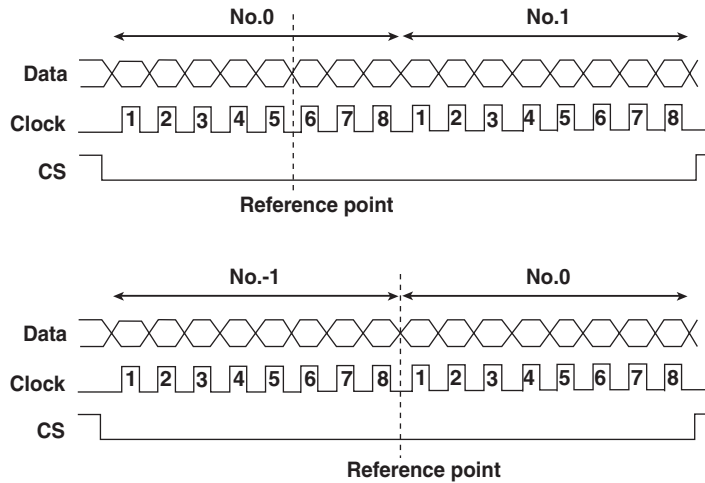

Note

If you set the reference point to Trigger Position, the byte containing the trigger point is analysis number 0. However, if a trigger is activated on the trigger conditions of the SPI Bus signal, the trigger point is the byte boundary. Hence, the analysis number of the byte on which the trigger is activated is 0 or -1.

• **Data1 and Data2 Values**

The Data1 and Data2 values are displayed in hexadecimal. However, below are some exceptions.

- When the data is less than 8 bits, “-” is displayed.
- **CS**
Displays the CS signal enable status. Note the following:
 - When none of the CS signal is ON, blank is displayed.
 - When only one CS signal is ON, the status H or L of the CS signal is displayed.

• **Display Example of Analysis Data**

Examples of analysis using different analysis conditions are indicated below.

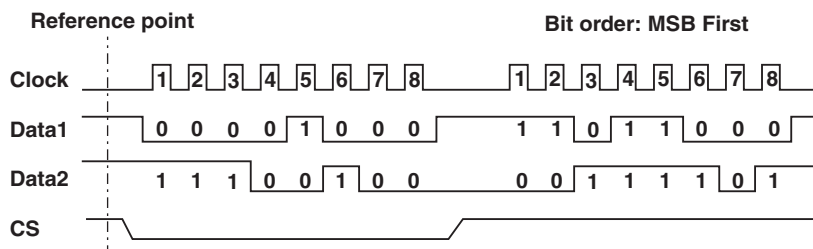

Analysis Condition Clock (CH1)= \bar{f} and CS (CH4)=L

Display Items	Analysis Data Display
Analysis number (No.)	0
Hexadecimal display of Data1 (Dt1)	08
Hexadecimal display of Data2 (Dt2)	E4
Status of the CS signal (CS)	L

Analysis Condition Clock (CH1)= \bar{f} and CS (CH4)=H

Display Items	Analysis Data Display
Analysis number (No.)	0
Hexadecimal display of Data1 (Dt1)	D8
Hexadecimal display of Data2 (Dt2)	3D
Status of the CS signal (CS)	H

Analysis Condition Clock (CH1)= \bar{f} and CS (CH4)=X

Display Items	Analysis Data Display	
Analysis number (No.)	0	1
Hexadecimal display of Data1 (Dt1)	08	D8
Hexadecimal display of Data2 (Dt2)	E4	3D
Status of the CS signal (CS)	L	H

Note

- If an arbitrary data is selected (highlighted) in the analysis data slit, the zoom position moves to the beginning of the data. Conversely, if you move the zoom position, the data corresponding to the zoom position is highlighted.
- If the CS signal is ON and the CS signal on the main waveform display screen does not contain a transition point from H to L or L to H, the I/O data is not analyzed.
- Analysis and search is not possible while waveform acquisition is in progress.
- Analysis and search cannot be performed on accumulated waveforms. However, analysis and search are possible on the accumulated waveform remaining as a history waveform.

Detailed List of Analysis Data: Detail

More detailed information of the analysis data can be listed. The following information can be displayed.

- Analysis number
- Time from the reference point
Displays the time from the reference point to the first bit of each data point.
- Data1 and Data2 values
You can display the values by selecting hexadecimal or binary for the notation system. However, if the data does not consist of 8 bits or if indefinite data exists, the display is the same as "Data1 and Data2 Values" on page 2-28.
- CS signal status

Setting the Search Condition: Search Setup

You can set the following conditions.

- **Search Type**

You can select the search type.

Frame Pattern (Pattern Search)

Searches the analysis data of Data1 or Data2 that matches the determination pattern specified at the byte level.

Indefinite State (Indefinite Data Search)

Searches indefinite data from the analysis data of Data1 or Data2.

- **When Search Type Is Set to Frame Pattern**

You can search the analysis data of Data1 or Data2 that matches the determination pattern specified at the byte level. Specify the following items.

Notation System of Determination Pattern: Pattern Format

Set the notation system of the specified determination pattern to hexadecimal or binary. The notation of the determination pattern described later changes accordingly.

Data to Be Searched: Source

Set the data to be searched to Data1 or Data2.

Data Length of the Determination Pattern: Data Byte

Select the data length of the determination pattern in the range of 1 to 8 bytes. The number of specified bytes of the determination pattern described later changes accordingly.

Determination Pattern: Data Pattern

Set the determination pattern according to the notation system setting (hexadecimal or binary).

- Bits that are set to "X" are not determined. Such bits are always handled as though the data matches the determination pattern regardless of the status.
- If there are bits set to X in binary, \$ is displayed when the notation system is changed to hexadecimal.
- The read direction of the bits is the same as the setting for the analysis (see section 2-26).

- **When Search Type Is Set to Indefinite State**

You can search indefinite data from the analysis data of Data1 or Data2 at the byte level. Set the data to be searched to Data1 or Data2.

Note

- Indefinite data is always considered matched to the specified status.
- If analysis is performed with CS signal set to ON, the data being analyzed is considered to be delimited at the point where the status of the CS signal changes. In this case, search is also performed by considering the data to be delimited at that point. For example, if a total of 5 bytes consisting of the data to be analyzed and CS signal as shown in the following figure is analyzed by changing the CS signal setting, search cannot be performed using the same conditions.
- Analyzing with the CS signal set to ON (enable status of the CS signal is set to L)
Because data cannot be searched over two CS intervals, search cannot be performed with the data length of the determination pattern to 4 or 5 bytes.
- Analyzing with None of the CS signals set to ON
The data length of the data to be searched and the CS interval are independent. Searching is possible with the data length of the determination pattern set to 4 or 5 bytes.

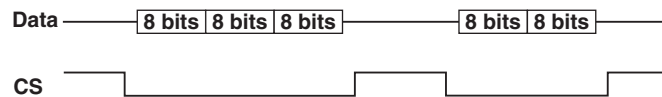

Executing the Search: Next, Prev

Press the Next or Prev soft key to execute the search. The search progresses (pattern or indefinite data search) as follows depending on the search type.

For Pattern Searches

Next: Searches frames after (to the right of) the currently selected frame.

Prev: Searches frames before (to the left of) the currently selected frame.

For Indefinite Data Searches

Next: Searches frames after (to the right of) the current zoom position (Z1 Pos).

Prev: Searches frames before (to the left of) the current zoom position (Z1 Pos).

- **Displaying the Search Result**

For Pattern Searches

If a waveform that matches the specified data pattern (Data1 or Data2 pattern) is found, the zoom position (Z1 Pos) moves to the beginning the pattern.

If all patterns are set to "X," the message "Pattern is not specified." (error code: 730) appears.

For Indefinite Data Searches

The zoom position (Z1 Pos) moves to the front of the indefinite data.

2.6 Saving the Data of the Detailed Analysis List

The data of the detailed analysis list can be saved to a file in ASCII format.

CAUTION

Do not remove the storage medium (disk) or turn OFF the power when the access indicator or icon of the storage medium is blinking. Doing so can damage the storage medium or destroy the data on the medium.

Procedure

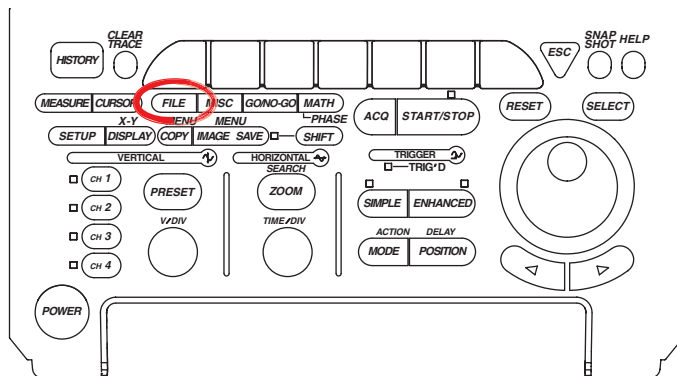

- To exit the menu during operation, press **ESC** located above the soft keys.
- In the procedural explanation below, the term *jog shuttle* & **SELECT** refers to the operation of selecting/setting items and entering values using the *jog shuttle* and **SELECT** and **RESET** keys. For details on this operation, see sections 4.1 or 4.2 in the DL1720E/DL1740E/DL1740EL User's Manual.
- For a description of the operation using a USB keyboard or a USB mouse, see section 4.3 in the DL1720E/DL1740E/DL1740EL User's Manual.

1. Press **FILE**. The FILE menu appears.
2. Press the **File Item** soft key. The File Item menu appears.

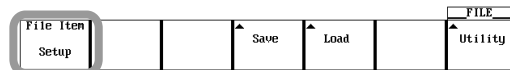

3. Press the **SPI Bus** soft key.

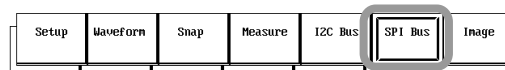

4. Press the **Save** soft key. The Save menu appears.



Selecting Save Destination Medium and Directory

5. Carry out steps 13 to 15 on page 12-14 in the *DL1720E/DL1740E/DL1740EL User's Manual (IM701730-01E)*.

Setting the File Name and Comment

6. Carry out steps 16 to 19 on page 12-14 in the *DL1720E/DL1740E/DL1740EL User's Manual (IM701730-01E)*.

Executing the Save Operation

- Press the **Save Exec** soft key. The data is saved to the directory indicated by Path=..... At the same time, the Save Exec soft key changes to the Abort soft key.

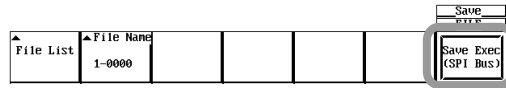
**Aborting the Save Operation**

- Press the **Abort** soft key. The save operation is aborted. At the same time, the Abort soft key changes to the Save Exec soft key.

Specifying the Files to Be Displayed in the File List Window and Displaying Properties

- Carry out steps 22 to 25 on page 12-15 in the *DL1720E/DL1740E/DL1740EL User's Manual (IM701730-01E)*.

Explanation

The analysis results of SPI signals can be saved to a file in ASCII format. The contents of the detailed analysis list of the SPI signal are saved as-is to the file. The extension is .txt.

The file size is as follows:

$$\text{File size} = (\text{number of bytes per data point}^1 \times \text{number of analysis results}) + 44 \text{ bytes}^2$$

- The number of bytes per data varies depending on the data type.
 - 40 bytes (Data2) minimum.: Analysis data without CS
 - 44 bytes (CS) maximum.: Analysis data with multiple CSs and CS is set to CH4
- The data size of the title is 44 bytes.

[Save example]

No.	Time(ms)	Data1	Data2	CS
-6	-0.010	00	11	L
-5	-0.009	00	22	L
-4	-0.007	00	33	L
-3	-0.006	00	11	L
-2	-0.004	00	22	L
-1	-0.003	00	33	L
0	-0.001	00	66	L
1	0.000	00	44	L
2	0.002	00	55	L
3	0.003	00	11	L
4	0.005	00	22	L
5	0.006	00	33	L
6	0.008	00	44	L
7	0.009	00	55	L
8	0.011	00	66	L

• Precautions to Be Taken When Saving the Data

- The maximum number of files that can be saved when the auto naming function is ON is 1150.
- If the total number of files and directories exceed 2500 in a single directory, the contents of the File List box are no longer displayed.

2.7 Error Messages

A message may appear during operation. This section describes the meanings of the messages and their corrective actions. This section lists only the error messages related to the SPI Bus signal analysis function. There are other error messages related to the DL1740 and communications. These messages are described in the *DL1720E/DL1740E/DL1740EL User's Manual (IM701730-01E)* and the *DL1720E/DL1740E/DL1740EL Communication Interface User's Manual (IM701730-17E)*.

You can set the messages to be displayed in English or Japanese. For the procedure of setting the message language, see section 15.1, "Changing the Menu Language/Message Language and Turning ON/OFF the Click Sound" in the *DL1720E/DL1740E/DL1740EL User's Manual (IM701730-01E)*.

If the corrective action requires servicing, contact your nearest YOKOGAWA dealer for repairs.

Code	Message	Action	Page
37	Aborted the analysis.	–	2-25
38	Data not detected. Execute again after changing the setting or reacquiring the waveform.	–	2-5, 2-11, 2-21, 2-25
739	Analyzed data does not exist. Execute the analysis.	Execute the analysis.	2-21, 2-25
870	Cannot be specified. Invalid byte or bit.	Increase the number of bytes.	2-6, 2-10
871	Cannot be set when CS channels are not specified.	–	2-20, 2-26

2.8 Communication Commands

This section contains only the communication commands related to the SPI Bus signal analysis function. For a description of other DL7440/DL7480 communication commands, see the *DL1720E/DL1740E/DL1740EL Communication Interface User's Manual (IM701730-17E)*.

Command	Function	Page
SPI Analyzer Group		
:SEARCh:SPI?	Queries all settings related to the analysis* function.	2-38
:SEARCh:SPI:ANALyze?	Queries all settings related to the execution of the analysis.*	2-38
:SEARCh:SPI:ANALyze:ABORt	Aborts the execution of the Analysis.*	2-39
:SEARCh:SPI:ANALyze:EXECute	Executes the analysis.*	2-39
:SEARCh:SPI:ANALyze:SETup?	Queries all settings related to the analysis* conditions.	2-39
:SEARCh:SPI:ANALyze:SETup:BITorder	Sets the bit order of analysis* data or queries the current setting.	2-39
:SEARCh:SPI:ANALyze:SETup:CLOCK?	Queries all settings related the clock signal in the analysis.*	2-39
:SEARCh:SPI:ANALyze:SETup:CLOCK:HYSteresis	Sets the hysteresis for the detection level of the clock signal in the analysis* or queries the current setting.	2-39
:SEARCh:SPI:ANALyze:SETup:CLOCK:LEVel	Sets the detection level of the clock signal in the analysis* or queries the current setting.	2-39
:SEARCh:SPI:ANALyze:SETup:CLOCK:POLarity	Sets the slope of the clock signal in the analysis* or queries the current setting.	2-39
:SEARCh:SPI:ANALyze:SETup:CS?	Queries all settings related the chip select signal (CS) in the analysis.*	2-40
:SEARCh:SPI:ANALyze:SETup:CS:CHANnel<x>?	Queries all settings related to each channel of the chip select signal (CS) in the analysis.*	2-40
:SEARCh:SPI:ANALyze:SETup:CS:CHANnel<x>:LEVel	Sets the level of each channel of the chip select signal (CS) in the analysis* or queries the current setting.	2-40
:SEARCh:SPI:ANALyze:SETup:CS:CHANnel<x>:MODE	Sets whether to handle the channel as a chip select signal (ON/OFF) in the analysis* or queries the current setting.	2-40
:SEARCh:SPI:ANALyze:SETup:CS:ESTate	Sets the enable status of the chip select signal (CS) in the analysis* or queries the current setting.	2-40
:SEARCh:SPI:ANALyze:SETup:DATA<x>?	Queries all settings related to the data input/output signal (Data1/Data2) in the analysis.*	2-40
:SEARCh:SPI:ANALyze:SETup:DATA<x>:LEVel	Sets the threshold level of the data input/output signal (Data1/Data2) in the analysis* or queries the current setting.	2-41
:SEARCh:SPI:ANALyze:SETup:DATA<x>:MODE	Enables/Disables the data input/output signal (Data1/Data2) in the analysis* or queries the current setting.	2-41
:SEARCh:SPI:ANALyze:SETup:MPOSITION	Sets the reference point when the reference point of the analysis* is set to manual or queries the current setting.	2-41
:SEARCh:SPI:ANALyze:SETup:RPOINT	Sets whether to set the reference point of the analysis* to the trigger position or set it manually or queries the current setting.	2-41
:SEARCh:SPI:LIST?	Outputs one byte of analysis* result as a character string.	2-41
:SEARCh:SPI:SEARCh?	Queries all settings related to the analysis* result search.	2-41
:SEARCh:SPI:SEARCh:DATA?	Queries all settings related to the data pattern search on the analysis* result.	2-41
:SEARCh:SPI:SEARCh:DATA:BYTE	Sets the number of bytes of the data pattern search on the analysis* result or queries the current setting.	2-42

2.8 Communication Commands

Command	Function	Page
:SEARCH:SPI:SEARCH:DATA:HEXa<x>	Sets the pattern of the data pattern search on the analysis* result in hexadecimal.	2-42
:SEARCH:SPI:SEARCH:DATA:PATtern<x>	Sets the pattern of data pattern search on the analysis* result in binary or queries the current setting.	2-42
:SEARCH:SPI:SEARCH:NEXT?	Executes the search on the data after the current byte on the analysis* result.	2-42
:SEARCH:SPI:SEARCH:PFORmat	Sets the pattern format of the data pattern search on the analysis* result or queries the current setting.	2-42
:SEARCH:SPI:SEARCH:PREVious?	Executes the search on the data before the current byte on the analysis* result.	2-42
:SEARCH:SPI:SEARCH:SOURce	Sets the data to be searched on the analysis* result or queries the current setting.	2-42
:SEARCH:SPI:SEARCH:TYPE	Sets the analysis* result search type or queries the current setting.	2-42
:SEARCH:TYPE	Sets the search type or queries the current setting.	2-42
SPI File Group		
:FILE:SAVE:SPI:ABORt	Aborts the saving of the data of the detailed analysis list of the analysis.*	2-43
:FILE:SAVE:SPI[:EXEcute]	Executes the saving of the data of the detailed analysis list of the analysis* (overlap command).	2-43
SPI Trigger Group		
:TRIGger:SPI?	Queries all settings related to the trigger.*	2-45
:TRIGger:SPI:BCOunt	Sets the trigger* byte count or queries the current setting.	2-45
:TRIGger:SPI:SETup?	Queries all settings related to the trigger.*	2-45
:TRIGger:SPI:SETup:ABCOunt	Sets the method of comparing Pattern B of the trigger* or queries the current setting.	2-45
:TRIGger:SPI:SETup:APATtern?	Queries all settings related to Pattern A of the trigger* or queries the current setting.	2-45
:TRIGger:SPI:SETup:APATtern:BYTE	Sets the number of bytes of Pattern A of the trigger* or queries the current setting.	2-46
:TRIGger:SPI:SETup:APATtern:CONDition	Sets the Pattern A condition of the trigger* or queries the current setting.	2-46
:TRIGger:SPI:SETup:APATtern:HEXa<x>	Sets the Pattern A pattern of the trigger* at the byte level in hexadecimal.	2-46
:TRIGger:SPI:SETup:APATtern:MODE	Enables/Disables Pattern A of the trigger* or queries the current setting.	2-46
:TRIGger:SPI:SETup:APATtern:PATtern<x>	Sets the Pattern A pattern of the trigger* at the byte level in binary or queries the current setting.	2-46
:TRIGger:SPI:SETup:BITorder	Sets the bit order of the pattern of the trigger* or queries the current setting.	2-46
:TRIGger:SPI:SETup:BPATtern?	Queries all settings related to Pattern B of the trigger* or queries the current setting.	2-46
:TRIGger:SPI:SETup:BPATtern:BYTE	Sets the number of bytes of Pattern B of the trigger* or queries the current setting.	2-46
:TRIGger:SPI:SETup:BPATtern:CONDition	Sets the Pattern B condition of the trigger* or queries the current setting.	2-47
:TRIGger:SPI:SETup:BPATtern:HEXa<x>	Sets the Pattern B pattern of the trigger* at the byte level in hexadecimal.	2-47
:TRIGger:SPI:SETup:BPATtern:MODE	Enables/Disables Pattern B of the trigger* or queries the current setting.	2-47
:TRIGger:SPI:SETup:BPATtern:PATtern<x>	Sets the Pattern B pattern of the trigger* at the byte level in binary or queries the current setting.	2-47
:TRIGger:SPI:SETup:BPATtern:TRACe	Sets the data to be used as Pattern B of the trigger* or queries the current setting.	2-47
:TRIGger:SPI:SETup:SPOLarity	Sets the edge slope of the clock signal (SCK) of the trigger* or queries the current setting.	2-47
:TRIGger:SPI:SETup:SSEnable	Sets the enable state of the slave select signal (SS) of the trigger* or queries the current setting.	2-47
:TRIGger:TYPE	Sets the trigger type or queries the current setting.	2-48

* In the explanation of the function of each command in this section, *analysis* refers to SPI Bus signal analysis. *Trigger* refers to the trigger of the SPI Bus signal analysis function.

• **SPI Analyzer Group**

Commands in the SPI Analyzer group can be used to set and query the SPI Bus signal analysis function in the same fashion as the SHIFT + ZOOM key on the front panel.

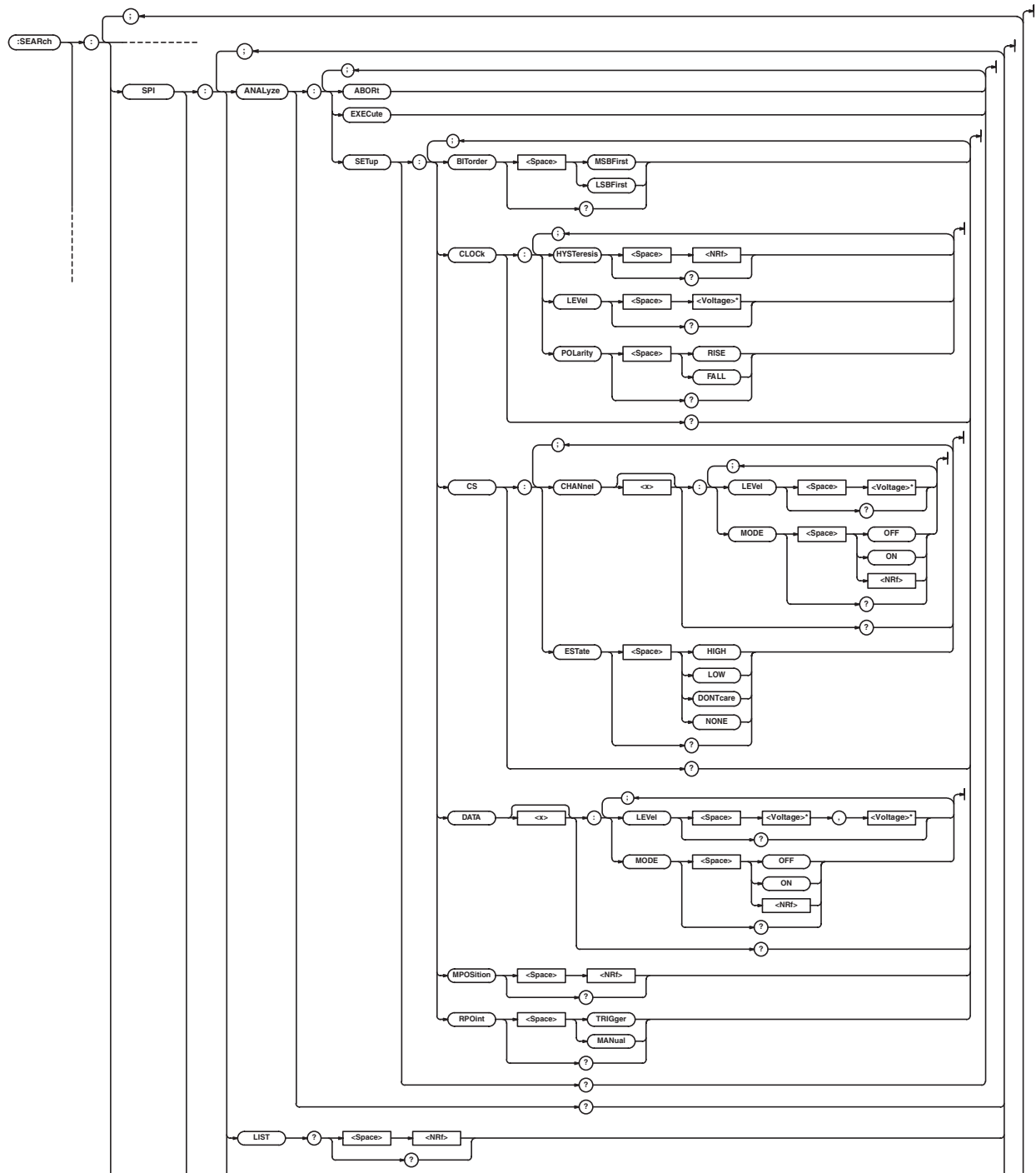

2.8 Communication Commands

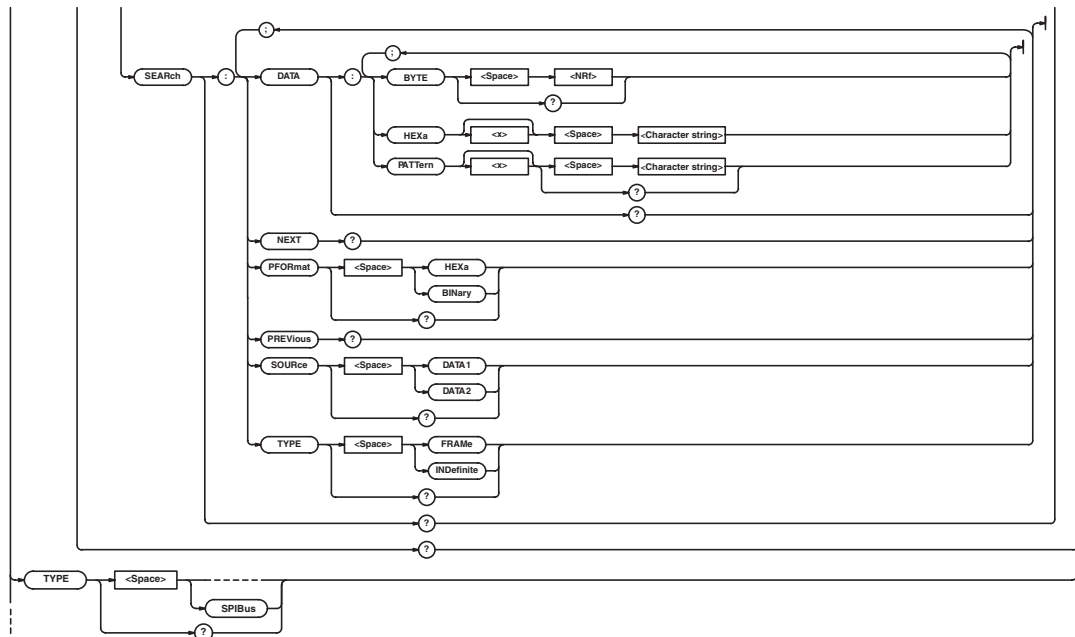

* <Current> when a current probe is used.

:SEARCH:SPI?

Function Queries all settings related to the analysis function.

Syntax :SEARCH:SPI?

Example :SEARCH:SPI? -> :SEARCH:SPI:
 ANALYZE:SETUP:CLOCK:LEVEL 0.0E+00;
 HYSTERESIS 0.30;POLARITY RISE;;
 SEARCH:SPI:ANALYZE:SETUP:DATA1:
 MODE 1;LEVEL 0.0E+00,0.0E+00;;
 SEARCH:SPI:ANALYZE:SETUP:DATA2:
 MODE 1;LEVEL 0.0E+00,0.0E+00;;
 SEARCH:SPI:ANALYZE:SETUP:CS:
 CHANNEL4:MODE 0;LEVEL 0.0E+00;;
 SEARCH:SPI:ANALYZE:SETUP:CS:
 CHANNEL5:MODE 0;LEVEL 0.0E+00;;
 SEARCH:SPI:ANALYZE:SETUP:CS:
 CHANNEL6:MODE 0;LEVEL 0.0E+00;;
 SEARCH:SPI:ANALYZE:SETUP:CS:
 CHANNEL7:MODE 0;LEVEL 0.0E+00;;
 SEARCH:SPI:ANALYZE:SETUP:CS:
 CHANNEL8:MODE 0;LEVEL 0.0E+00;;
 SEARCH:SPI:ANALYZE:SETUP:CS:LOGIC:
 A0 0;A1 0;A2 0;A3 0;A4 0;A5 0;A6 0;
 A7 0;;SEARCH:SPI:ANALYZE:SETUP:
 CS:ESTATE NONE;;SEARCH:SPI:
 ANALYZE:SETUP:RPOINT TRIGGER;
 MPOSITION 0.0000000;
 BITORDER MSBFIRST;;SEARCH:SPI:
 SEARCH:TYPE FRAME;PFORMAT HEXA;
 SOURCE DATA1;DATA:BYTE 8;
 PATTERN1 "XXXXXXXX";
 PATTERN2 "XXXXXXXX";
 PATTERN3 "XXXXXXXX";
 PATTERN4 "XXXXXXXX";
 PATTERN5 "XXXXXXXX";

PATTERN6 "XXXXXXXX";
 PATTERN7 "XXXXXXXX";
 PATTERN8 "XXXXXXXX"

:SEARCH:SPI:ANALyze?

Function Queries all settings related to the execution of the analysis.

Syntax :SEARCH:SPI:ANALyze?

Example :SEARCH:SPI:ANALyze? -> :SEARCH:
 SPI:ANALYZE:SETUP:CLOCK:
 LEVEL 0.0E+00;HYSTERESIS 0.30;
 POLARITY RISE;;SEARCH:SPI:
 ANALYZE:SETUP:DATA1:MODE 1;
 LEVEL 0.0E+00,0.0E+00;;SEARCH:SPI:
 ANALYZE:SETUP:DATA2:MODE 1;
 LEVEL 0.0E+00,0.0E+00;;SEARCH:SPI:
 ANALYZE:SETUP:CS:CHANNEL4:MODE 0;
 LEVEL 0.0E+00;;SEARCH:SPI:ANALYZE:
 SETUP:CS:CHANNEL5:MODE 0;
 LEVEL 0.0E+00;;SEARCH:SPI:ANALYZE:
 SETUP:CS:CHANNEL6:MODE 0;
 LEVEL 0.0E+00;;SEARCH:SPI:ANALYZE:
 SETUP:CS:CHANNEL7:MODE 0;
 LEVEL 0.0E+00;;SEARCH:SPI:ANALYZE:
 SETUP:CS:CHANNEL8:MODE 0;
 LEVEL 0.0E+00;;SEARCH:SPI:ANALYZE:
 SETUP:CS:LOGIC:A0 0;A1 0;A2 0;A3 0;
 A4 0;A5 0;A6 0;A7 0;;SEARCH:SPI:
 ANALYZE:SETUP:CS:ESTATE NONE;;
 SEARCH:SPI:ANALYZE:SETUP:
 RPOINT TRIGGER;MPOSITION 0.0000000;
 BITORDER MSBFIRST

:SEARCH:SPI:ANALYZE:ABORT

Function Aborts the execution of the Analysis.
 Syntax :SEARCH:SPI:ANALYZE:ABORT
 Example :SEARCH:SPI:ANALYZE:ABORT

:SEARCH:SPI:ANALYZE:EXECUTE

Function Executes the analysis.
 Syntax :SEARCH:SPI:ANALYZE:EXECUTE
 Example :SEARCH:SPI:ANALYZE:EXECUTE

:SEARCH:SPI:ANALYZE:SETUP?

Function Queries all settings related to the analysis.
 Syntax :SEARCH:SPI:ANALYZE:SETUP?
 Example :SEARCH:SPI:ANALYZE:SETUP? ->
 :SEARCH:SPI:ANALYZE:SETUP:CLOCK:
 LEVEL 0.0E+00;HYSTERESIS 0.30;
 POLARITY RISE;;SEARCH:SPI:
 ANALYZE:SETUP:DATA1:MODE 1;
 LEVEL 0.0E+00,0.0E+00;;SEARCH:SPI:
 ANALYZE:SETUP:DATA2:MODE 1;
 LEVEL 0.0E+00,0.0E+00;;SEARCH:SPI:
 ANALYZE:SETUP:CS:CHANNEL4:MODE 0;
 LEVEL 0.0E+00;;SEARCH:SPI:ANALYZE:
 SETUP:CS:CHANNEL5:MODE 0;
 LEVEL 0.0E+00;;SEARCH:SPI:ANALYZE:
 SETUP:CS:CHANNEL6:MODE 0;
 LEVEL 0.0E+00;;SEARCH:SPI:ANALYZE:
 SETUP:CS:CHANNEL7:MODE 0;
 LEVEL 0.0E+00;;SEARCH:SPI:ANALYZE:
 SETUP:CS:CHANNEL8:MODE 0;
 LEVEL 0.0E+00;;SEARCH:SPI:ANALYZE:
 SETUP:CS:LOGIC:A0 0;A1 0;A2 0;A3 0;
 A4 0;A5 0;A6 0;A7 0;;SEARCH:SPI:
 ANALYZE:SETUP:CS:ESTATE NONE;;
 SEARCH:SPI:ANALYZE:SETUP:
 RPOINT TRIGGER;MPOSITION 0.0000000;
 BITORDER MSBFIRST

:SEARCH:SPI:ANALYZE:SETUP:BITORDER

Function Sets the bit order of analysis data or queries the current setting.
 Syntax :SEARCH:SPI:ANALYZE:SETUP:BITORDER
 {MSBFirst|LSBFirst}
 :SEARCH:SPI:ANALYZE:SETUP:BITORDER?
 Example :SEARCH:SPI:ANALYZE:SETUP:
 BITORDER
 MSBFIRST:SEARCH:SPI:ANALYZE:
 SETUP:BITORDER? -> :SEARCH:SPI:
 ANALYZE:SETUP:BITORDER MSBFIRST

:SEARCH:SPI:ANALYZE:SETUP:CLOCK?

Function Queries all settings related the clock signal in the analysis.
 Syntax :SEARCH:SPI:ANALYZE:SETUP:CLOCK?
 Example :SEARCH:SPI:ANALYZE:SETUP:CLOCK? ->
 :SEARCH:SPI:ANALYZE:SETUP:CLOCK:
 LEVEL 1.000E+00;HYSTERESIS 0.3;
 POLARITY RISE

:SEARCH:SPI:ANALYZE:SETUP:CLOCK:HYSTERESIS

Function Sets the hysteresis for the detection level of the clock signal in the analysis or queries the current setting.
 Syntax :SEARCH:SPI:ANALYZE:SETUP:CLOCK:
 HYSTERESIS {<NRf>}
 :SEARCH:SPI:ANALYZE:SETUP:CLOCK:
 HYSTERESIS?
 <NRf>=0.3 to 4.0 (div, 0.1 steps)
 Example :SEARCH:SPI:ANALYZE:SETUP:CLOCK:
 HYSTERESIS 0.5
 :SEARCH:SPI:ANALYZE:SETUP:CLOCK:
 HYSTERESIS? -> :SEARCH:SPI:ANALYZE:
 SETUP:CLOCK:HYSTERESIS 0.5

:SEARCH:SPI:ANALYZE:SETUP:CLOCK:LEVEL

Function Sets the detection level of the clock signal in the analysis or queries the current setting.
 Syntax :SEARCH:SPI:ANALYZE:SETUP:CLOCK:
 LEVEL {<Voltage>}
 :SEARCH:SPI:ANALYZE:SETUP:CLOCK:
 LEVEL?
 <Voltage>=8 divisions within the screen (0.01 division steps).
 Example :SEARCH:SPI:ANALYZE:SETUP:CLOCK:
 LEVEL1V:SEARCH:SPI:ANALYZE:SETUP:CLOCK:
 LEVEL?-> :SEARCH:SPI:ANALYZE:SETUP:
 CLOCK:LEVEL 1.000E+00
 Description When a current probe is set to CH1, this command sets or queries the <Current> value.

:SEARCH:SPI:ANALYZE:SETUP:CLOCK:POLARITY

Function Sets the slope of the clock signal in the analysis or queries the current setting.
 Syntax :SEARCH:SPI:ANALYZE:SETUP:CLOCK:
 POLARITY {RISE|FALL}
 :SEARCH:SPI:ANALYZE:SETUP:CLOCK:
 POLARITY?
 Example :SEARCH:SPI:ANALYZE:SETUP:CLOCK:
 POLARITY RISE
 :SEARCH:SPI:ANALYZE:SETUP:CLOCK:
 POLARITY? -> :SEARCH:SPI:ANALYZE:
 SETUP:CLOCK:POLARITY RISE

2.8 Communication Commands

:SEARCH:SPI:ANALyze:SETup:CS?

Function Queries all settings related the chip select signal (CS) in the analysis.

Syntax :SEARCH:SPI:ANALyze:SETup:CS?

Example :SEARCH:SPI:ANALyze:SETup:CS? ->
:SEARCH:SPI:ANALyze:SETup:CS:CHANNEL4:
MODE 0;LEVEL 0.0E+00;:SEARCH:SPI:
ANALyze:SETup:CS:CHANNEL5:MODE 0;
LEVEL 0.0E+00;:SEARCH:SPI:ANALyze:
SETup:CS:CHANNEL6:MODE 0;
LEVEL 0.0E+00;:SEARCH:SPI:ANALyze:
SETup:CS:CHANNEL7:MODE 0;
LEVEL 0.0E+00;:SEARCH:SPI:ANALyze:
SETup:CS:CHANNEL8:MODE 0;
LEVEL 0.0E+00;:SEARCH:SPI:ANALyze:
SETup:CS:LOGIC:A0 0;A1 0;A2 0;A3 0;
A4 0;A5 0;A6 0;A7 0;:SEARCH:SPI:
ANALyze:SETup:CS:ESTate NONE

:SEARCH:SPI:ANALyze:SETup:CS: CHANnel<x>?

Function Queries all settings related to each channel of the chip select signal (CS) in the analysis.

Syntax :SEARCH:SPI:ANALyze:SETup:CS:
CHANnel<x>?
<x>=4

Example :SEARCH:SPI:ANALyze:SETup:CS:
CHANnel4?-> :SEARCH:SPI:ANALyze:
SETup:CS:CHANnel4:MODE 1;
LEVEL 1.000E+00

:SEARCH:SPI:ANALyze:SETup:CS: CHANnel<x>:LEVel

Function Sets the level of each channel of the chip select signal (CS) in the analysis or queries the current setting.

Syntax :SEARCH:SPI:ANALyze:SETup:CS:
CHANnel<x>:LEVel {<Voltage>}
:SEARCH:SPI:ANALyze:SETup:CS:
CHANnel4:LEVel?
<x>=4
<Voltage>=8 divisions within the screen (0.01
division steps).

Example :SEARCH:SPI:ANALyze:SETup:CS:
CHANnel4:LEVel 1V
:SEARCH:SPI:ANALyze:SETup:CS:
CHANnel4:LEVel? -> :SEARCH:SPI:
ANALyze:SETup:CS:CHANnel4:
LEVEL 1.000E+00

Description When a current probe is used, this command sets or queries the <Current> value.

:SEARCH:SPI:ANALyze:SETup:CS: CHANnel<x>:MODE

Function Sets whether to handle the channel as a chip select signal (ON/OFF) in the analysis or queries the current setting.

Syntax :SEARCH:SPI:ANALyze:SETup:CS:
CHANnel4:MODE {<Boolean>}
:SEARCH:SPI:ANALyze:SETup:CS:
CHANnel4:MODE?
<x>=4

Example :SEARCH:SPI:ANALyze:SETup:CS:
CHANnel4:MODE ON
:SEARCH:SPI:ANALyze:SETup:CS:
CHANnel4:MODE? -> :SEARCH:SPI:
ANALyze:SETup:CS:CHANnel4:MODE 1

:SEARCH:SPI:ANALyze:SETup:CS:ESTate

Function Sets the enable status of the chip select signal (CS) in the analysis or queries the current setting.

Syntax :SEARCH:SPI:ANALyze:SETup:CS:ESTate
{HIGH|LOW|DONTcare}
:SEARCH:SPI:ANALyze:SETup:CS:
ESTate?

Example :SEARCH:SPI:ANALyze:SETup:CS:
ESTate LOW
:SEARCH:SPI:ANALyze:SETup:CS:
ESTate? -> :SEARCH:SPI:ANALyze:
SETup:CS:ESTate LOW

:SEARCH:SPI:ANALyze:SETup:DATA<x>?

Function Queries all settings related to the data input/output signal (Data1/Data2) in the analysis.

Syntax :SEARCH:SPI:ANALyze:SETup:DATA<x>?
<x>=1, 2

Example :SEARCH:SPI:ANALyze:SETup:DATA1? ->
:SEARCH:SPI:ANALyze:SETup:DATA1:
MODE 1;LEVEL 1.000E+00,0.000E+00

:SEARCH:SPI:ANALYZE:SETUP:DATA<x>:LEVEL

Function	Sets the threshold level of the data input/output signal (Data1/Data2) in the analysis or queries the current setting.
Syntax	:SEARCH:SPI:ANALYZE:SETUP:DATA<x>:LEVEL {<Voltage>,<Voltage>} :SEARCH:SPI:ANALYZE:SETUP:DATA<x>:LEVEL? <Voltage>=8 divisions within the screen (0.01 division steps). <x>=1, 2
Example	:SEARCH:SPI:ANALYZE:SETUP:DATA1:LEVEL1V,0V :SEARCH:SPI:ANALYZE:SETUP:DATA1:LEVEL? -> :SEARCH:SPI:ANALYZE:SETUP:DATA1:LEVEL 1.000E+00,0.000E+00
Description	When <x>=1, the CH2 input is the data signal. When <x>=2, the CH3 input is the data signal. When a current probe is set to CH2 or CH3, this command sets or queries the <Current> value.

:SEARCH:SPI:ANALYZE:SETUP:DATA<x>:MODE

Function	Enables/Disables the data input/output signal (Data1/Data2) in the analysis or queries the current setting.
Syntax	:SEARCH:SPI:ANALYZE:SETUP:DATA<x>:MODE {<Boolean>} :SEARCH:SPI:ANALYZE:SETUP:DATA<x>:MODE? <x>=1, 2
Example	:SEARCH:SPI:ANALYZE:SETUP:DATA1:MODE ON :SEARCH:SPI:ANALYZE:SETUP:DATA1:MODE? -> :SEARCH:SPI:ANALYZE:SETUP:DATA1:MODE 1

:SEARCH:SPI:ANALYZE:SETUP:MPOSITION

Function	Sets the reference point when the reference point of the analysis is set to manual or queries the current setting.
Syntax	:SEARCH:SPI:ANALYZE:SETUP:MPOSITION {<NRF>} :SEARCH:SPI:ANALYZE:SETUP:MPOSITION? <NRF>=-5 to 5 divisions (10 divisions/displayed record length steps)
Example	:SEARCH:SPI:ANALYZE:SETUP:MPOSITION -4.000 :SEARCH:SPI:ANALYZE:SETUP:MPOSITION? -> :SEARCH:SPI:ANALYZE:SETUP:MPOSITION -4.00000

:SEARCH:SPI:ANALYZE:SETUP:RPOINT

Function	Sets whether to set the reference point of the analysis to the trigger position or set it manually or queries the current setting.
Syntax	:SEARCH:SPI:ANALYZE:SETUP:RPOINT {TRIGGER MANUAL} :SEARCH:SPI:ANALYZE:SETUP:RPOINT?
Example	:SEARCH:SPI:ANALYZE:SETUP:RPOINT TRIGGER :SEARCH:SPI:ANALYZE:SETUP:RPOINT? -> :SEARCH:SPI:ANALYZE:SETUP:RPOINT TRIGGER

:SEARCH:SPI:LIST?

Function	Outputs one byte of analysis result as a character string.
Syntax	SEARCH:SPI:LIST? {<NRF>} <NRF>=-80000 to 80000
Example	:SEARCH:SPI:LIST? 1 -> " 10.024 01010101 00000010 L"

:SEARCH:SPI:SEARCH?

Function	Queries all settings related to the analysis result search.
Syntax	:SEARCH:SPI:SEARCH?
Example	SEARCH:SPI:SEARCH? -> :SEARCH:SPI:SEARCH:TYPE FRAME;PFORMAT BINARY;SOURCE DATA1;DATA:BYTE 8;PATTERN1 "10X10X10";PATTERN2 "0X10X10X";PATTERN3 "X10X10X1";PATTERN4 "01X01X01";PATTERN5 "1X01X01X";PATTERN6 "X01X01X0";PATTERN7 "X10X10X1";PATTERN8 "11010101"

:SEARCH:SPI:SEARCH:DATA?

Function	Queries all settings related to the data pattern search on the analysis result.
Syntax	:SEARCH:SPI:SEARCH:DATA?
Example	:SEARCH:SPI:SEARCH:DATA? -> :SEARCH:SPI:SEARCH:DATA:BYTE 8;PATTERN1 "10X10X10";PATTERN2 "0X10X10X";PATTERN3 "X10X10X1";PATTERN4 "01X01X01";PATTERN5 "1X01X01X";PATTERN6 "X01X01X0";PATTERN7 "X10X10X1";PATTERN8 "11010101"

2.8 Communication Commands

:SEARCH:SPI:SEARCH:DATA:BYTE

Function Sets the number of bytes of the data pattern search on the analysis result or queries the current setting.

Syntax :SEARCH:SPI:SEARCH:DATA:BYTE
{<NRf>
:SEARCH:SPI:SEARCH:DATA:BYTE?
<NRf>=1 to 8

Example :SEARCH:SPI:SEARCH:DATA:BYTE 8
:SEARCH:SPI:SEARCH:DATA:BYTE? ->
:SEARCH:SPI:SEARCH:DATA:BYTE 8

:SEARCH:SPI:SEARCH:DATA:HEXa<x>

Function Sets the pattern of the data pattern search on the analysis result in hexadecimal.

Syntax :SEARCH:SPI:SEARCH:DATA:HEXa<x>
{<String>
<String>=2 characters by combining '0' to 'F'
and 'X'
<x>=1 to 8

Example :SEARCH:SPI:SEARCH:DATA:HEXa1 "1A"

:SEARCH:SPI:SEARCH:DATA:PATtern<x>

Function Sets the pattern of data pattern search on the analysis result in binary or queries the current setting.

Syntax :SEARCH:SPI:SEARCH:DATA:PATtern<x>
{<String>
:SEARCH:SPI:SEARCH:DATA:PATtern<x>?
<String>=8 characters by combining '0,' '1,' and
'X'
<x>=1 to 8

Example :SEARCH:SPI:SEARCH:DATA:
PATTERN1 "10X10X10"
:SEARCH:SPI:SEARCH:DATA:PATTERN1?
-> :SEARCH:SPI:SEARCH:DATA:
PATTERN1 "10X10X10"

:SEARCH:SPI:SEARCH:NEXT?

Function Executes the search on the data after the current byte on the analysis result.

Syntax :SEARCH:SPI:SEARCH:NEXT?

Example :SEARCH:SPI:SEARCH:NEXT? -> 10

Description If the search is successful, a value in the range of -80000 to 80000 is returned. If it fails, "NAN" is returned.

:SEARCH:SPI:SEARCH:PFORMAT

Function Sets the pattern format of the data pattern search on the analysis result or queries the current setting.

Syntax :SEARCH:SPI:SEARCH:PFORMAT
{HEXa|BINary}
:SEARCH:SPI:SEARCH:PFORMAT?

Example :SEARCH:SPI:SEARCH:PFORMAT BINARY
:SEARCH:SPI:SEARCH:PFORMAT? ->
:SEARCH:SPI:SEARCH:PFORMAT BINARY

:SEARCH:SPI:SEARCH:PREVIOUS?

Function Performs the analysis result search on the data before the current byte and returns the search position.

Syntax :SEARCH:SPI:SEARCH:PREVIOUS?

Example :SEARCH:SPI:SEARCH:PREVIOUS? -> -10

Description If the search is successful, a value in the range of -80000 to 80000 is returned. If it fails, "NAN" is returned.

:SEARCH:SPI:SEARCH:SOURCE

Function Sets the data to be searched on the analysis result or queries the current setting.

Syntax :SEARCH:SPI:SEARCH:SOURCE
{DATA1|DATA2}
:SEARCH:SPI:SEARCH:SOURCE?

Example :SEARCH:SPI:SEARCH:SOURCE DATA1
:SEARCH:SPI:SEARCH:SOURCE? ->
:SEARCH:SPI:SEARCH:SOURCE DATA1

:SEARCH:SPI:SEARCH:TYPE

Function Sets the analysis result search type or queries the current setting.

Syntax :SEARCH:SPI:SEARCH:TYPE
{FRAME|INDefinite}
:SEARCH:SPI:SEARCH:TYPE?

Example :SEARCH:SPI:SEARCH:TYPE FRAME
:SEARCH:SPI:SEARCH:TYPE? ->
:SEARCH:SPI:SEARCH:TYPE FRAME

:SEARCH:TYPE

Function Sets the search type or queries the current setting.

Syntax :SEARCH:TYPE {SPATtern|WIDTH|EDGE|
PPATtern|ASCRoll|SPIBus}
:SEARCH:TYPE?

Example :SEARCH:TYPE SPIBUS
:SEARCH:TYPE? ->
:SEARCH:TYPE SPIBUS

• SPI File Group

The commands in the SPI File Group can be used to execute/abort the saving of the data of the detailed analysis list of the SPI Bus signal in the same fashion as the FILE key on the front panel.

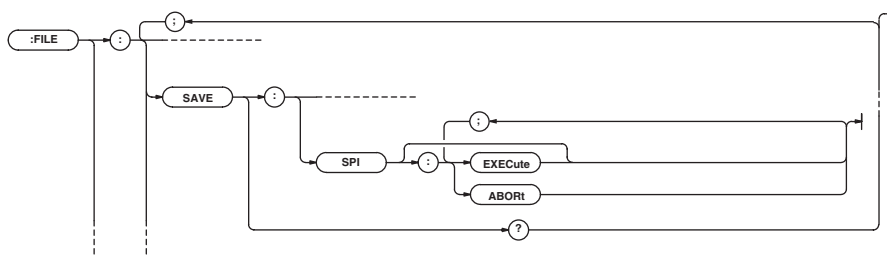

:FILE:SAVE:SPI:ABORT

Function Aborts the saving of the data of the detailed analysis list of the analysis in ASCII format.

Syntax :FILE:SAVE:SPI:ABORT

Example :FILE:SAVE:SPI:ABORT

:FILE:SAVE:SPI[:EXECUTE]

Function Executes the saving of the data of the detailed analysis list of the analysis in ASCII format.

This is an overlap command.

Syntax :FILE:SAVE:SPI[:EXECUTE]

Example :FILE:SAVE:SPI:EXECUTE

2.8 Communication Commands

• SPI Trigger Group

Commands in the SPI Trigger group can be used to set and query the trigger of the SPI Bus signal analysis function in the same fashion as the ENHANCED key on the front panel.

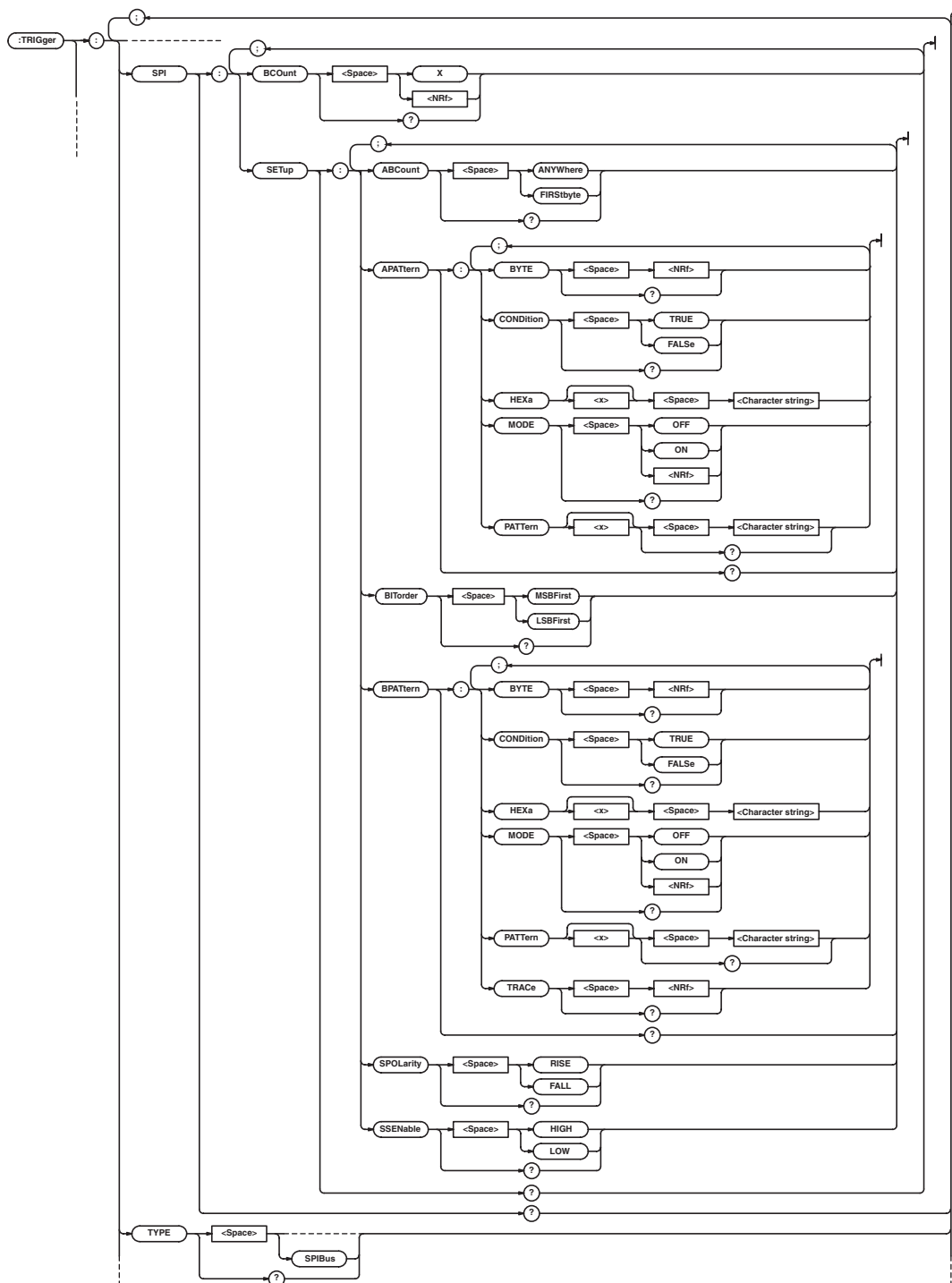

:TRIGger:SPI?

Function Queries all settings related to the trigger.

Syntax :TRIGger:SPI?

Example :TRIGGER:SPI? -> :TRIGGER:SPI:
COMBINATION ONLY;SETUP:
SPOLARITY RISE;APATTERN:MODE 0;
BYTE 8;CONDITION TRUE;
PATTERN1 "XXXXXXXX";
PATTERN2 "XXXXXXXX";
PATTERN3 "XXXXXXXX";
PATTERN4 "XXXXXXXX";
PATTERN5 "XXXXXXXX";
PATTERN6 "XXXXXXXX";
PATTERN7 "XXXXXXXX";
PATTERN8 "XXXXXXXX";
:TRIGGER:SPI:
SETUP:BPATTERN:TRACE 2;
MODE 0;BYTE 8;CONDITION TRUE;
PATTERN1 "XXXXXXXX";
PATTERN2 "XXXXXXXX";
PATTERN3 "XXXXXXXX";
PATTERN4 "XXXXXXXX";
PATTERN5 "XXXXXXXX";
PATTERN6 "XXXXXXXX";
PATTERN7 "XXXXXXXX";
PATTERN8 "XXXXXXXX";
:TRIGGER:SPI:
SETUP:ABCOUNT FIRSTBYTE;;:TRIGGER:
SPI:BCOUNT 0

:TRIGger:SPI:BCount

Function Sets the trigger byte count or queries the current setting.

Syntax :TRIGger:SPI:BCount {<NRF>|<x>}
:TRIGger:SPI:BCount?

Example :TRIGGER:SPI:BCOUNT 1
:TRIGGER:SPI:BCOUNT? ->
:TRIGGER:SPI:BCOUNT 1

:TRIGger:SPI:SETup?

Function Queries all settings related to the trigger.

Syntax :TRIGger:SPI:SETup?

Example :TRIGGER:SPI:SETUP? -> :TRIGGER:
SPI:SETUP:SPOLARITY RISE;APATTERN:
MODE 0;BYTE 8;CONDITION TRUE;
PATTERN1 "XXXXXXXX";
PATTERN2 "XXXXXXXX";
PATTERN3 "XXXXXXXX";
PATTERN4 "XXXXXXXX";
PATTERN5 "XXXXXXXX";
PATTERN6 "XXXXXXXX";
PATTERN7 "XXXXXXXX";
PATTERN8 "XXXXXXXX";:TRIGGER:SPI:
SETUP:BPATTERN:TRACE 2;MODE 0;
BYTE 8;CONDITION TRUE;
PATTERN1 "XXXXXXXX";
PATTERN2 "XXXXXXXX";
PATTERN3 "XXXXXXXX";
PATTERN4 "XXXXXXXX";
PATTERN5 "XXXXXXXX";
PATTERN6 "XXXXXXXX";
PATTERN7 "XXXXXXXX";
PATTERN8 "XXXXXXXX";:TRIGGER:SPI:
SETUP:ABCOUNT FIRSTBYTE

:TRIGger:SPI:SETup:ABCCount

Function Sets the method of comparing Pattern B of the trigger or queries the current setting.

Syntax :TRIGger:SPI:SETup:ABCCount
{FIRSTbyte|ANYWhere}
:TRIGger:SPI:SETup:ABCCount?

Example :TRIGGER:SPI:SETUP:
ABCOUNT FIRSTBYTE
:TRIGGER:SPI:SETUP:ABCOUNT? ->
:TRIGGER:SPI:SETUP:
ABCOUNT FIRSTBYTE

:TRIGger:SPI:SETup:APATtern?

Function Queries all settings related to Pattern A of the trigger or queries the current setting.

Syntax :TRIGger:SPI:SETup:APATtern?

Example :TRIGGER:SPI:SETUP:APATTERN? ->
:TRIGGER:SPI:SETUP:APATTERN:MODE 0;
BYTE 8;CONDITION TRUE;
PATTERN1 "XXXXXXXX";
PATTERN2 "XXXXXXXX";
PATTERN3 "XXXXXXXX";
PATTERN4 "XXXXXXXX";
PATTERN5 "XXXXXXXX";
PATTERN6 "XXXXXXXX";
PATTERN7 "XXXXXXXX";
PATTERN8 "XXXXXXXX"

2.8 Communication Commands

:TRIGger:SPI:SETup:APATtern:BYTE

Function Sets the number of bytes of Pattern A of the trigger or queries the current setting.

Syntax :TRIGger:SPI:SETup:APATtern:BYTE
{<NRf>}
:TRIGger:SPI:SETup:APATtern:BYTE?
<NRf>=1 to 8

Example :TRIGGER:SPI:SETUP:APATTERN:BYTE 1
:TRIGGER:SPI:SETUP:APATTERN:BYTE?
-> :TRIGGER:SPI:SETUP:APATTERN:
BYTE 1

:TRIGger:SPI:SETup:APATtern:CONDition

Function Sets the Pattern A condition of the trigger or queries the current setting.

Syntax :TRIGger:SPI:SETup:APATtern:
CONDition {TRUE|FALSE}
:TRIGger:SPI:SETup:APATtern:
CONDition?

Example :TRIGGER:SPI:SETUP:APATTERN:
CONDITION TRUE
:TRIGGER:SPI:SETUP:APATTERN:
CONDITION? -> :TRIGGER:SPI:SETUP:
APATTERN:CONDITION TRUE

:TRIGger:SPI:SETup:APATtern:HEXa<x>

Function Sets the Pattern A pattern of the trigger at the byte level in hexadecimal.

Syntax :TRIGger:SPI:SETup:APATtern:HEXa<x>
{<String>}
:TRIGger:SPI:SETup:APATtern:
HEXa<x>?
<String>=2 characters by combining '0' to 'F'
and 'X'
<x>=1 to 8

Example :TRIGGER:SPI:SETUP:APATTERN:
HEXA1 "1A"
:TRIGGER:SPI:SETUP:APATTERN:HEXA1?
-> :TRIGGER:SPI:SETUP:APATTERN:
HEXA1 "1A"

:TRIGger:SPI:SETup:APATtern:MODE

Function Enables/Disables Pattern A of the trigger or queries the current setting.

Syntax :TRIGger:SPI:SETup:APATtern:MODE
{<Boolean>}
:TRIGger:SPI:SETup:APATtern:MODE?

Example :TRIGGER:SPI:SETUP:APATTERN:MODE ON
:TRIGGER:SPI:SETUP:APATTERN:MODE?
-> :TRIGGER:SPI:SETUP:APATTERN:
MODE 1

:TRIGger:SPI:SETup:APATtern:PATTern<x>

Function Sets the Pattern A pattern of the trigger at the byte level in binary or queries the current setting.

Syntax :TRIGger:SPI:SETup:APATtern:
PATTern<x> {<String>}
:TRIGger:SPI:SETup:APATtern:
PATTern<x>?
<String>=8 characters by combining '0,' '1,' and
'X'
<x>=1 to 8

Example :TRIGGER:SPI:SETUP:APATTERN:
PATTERN1 "10X10X10"
:TRIGGER:SPI:SETUP:APATTERN:
PATTERN1? -> :TRIGGER:SPI:SETUP:
APATTERN:PATTERN1 "10X10X10"

:TRIGger:SPI:SETup:BITorder

Function Sets the bit order of the pattern of the trigger or queries the current setting.

Syntax :TRIGger:SPI:SETup:BITorder
{MSBfirst|LSBfirst}
:TRIGger:SPI:SETup:BITorder?

Example :TRIGGER:SPI:SETUP:
BITORDER MSBFIRST
:TRIGGER:SPI:SETUP:BITORDER? ->
:TRIGGER:SPI:SETUP:
BITORDER MSBFIRST

:TRIGger:SPI:SETup:BPATtern?

Function Queries all settings related to Pattern B of the trigger or queries the current setting.

Syntax :TRIGger:SPI:SETup:BPATtern?

Example :TRIGGER:SPI:SETUP:BPATTERN? ->
:TRIGGER:SPI:SETUP:BPATTERN:
TRACE 2;MODE 0;BYTE 8;
CONDITION TRUE;PATTERN1 "XXXXXXXX";
PATTERN2 "XXXXXXXX";
PATTERN3 "XXXXXXXX";
PATTERN4 "XXXXXXXX";
PATTERN5 "XXXXXXXX";
PATTERN6 "XXXXXXXX";
PATTERN7 "XXXXXXXX";
PATTERN8 "XXXXXXXX"

:TRIGger:SPI:SETup:BPATtern:BYTE

Function Sets the number of bytes of Pattern B of the trigger or queries the current setting.

Syntax :TRIGger:SPI:SETup:BPATtern:BYTE
{<NRf>}
:TRIGger:SPI:SETup:BPATtern:BYTE?
<NRf>=1 to 8

Example :TRIGGER:SPI:SETUP:BPATTERN:BYTE 1
:TRIGGER:SPI:SETUP:BPATTERN:BYTE?
-> :TRIGGER:SPI:SETUP:BPATTERN:
BYTE 1

:TRIGger:SPI:SETup:BPATtern:CONDition

Function Sets the Pattern B condition of the trigger or queries the current setting.

Syntax :TRIGger:SPI:SETup:BPATtern:CONDition {TRUE|FALSE}
:TRIGger:SPI:SETup:BPATtern:CONDition?

Example :TRIGGER:SPI:SETUP:BPATTERN:CONDITION TRUE
:TRIGGER:SPI:SETUP:BPATTERN:CONDITION? -> :TRIGGER:SPI:SETUP:BPATTERN:CONDITION TRUE

:TRIGger:SPI:SETup:BPATtern:HEXa<x>

Function Sets the Pattern B pattern of the trigger at the byte level in hexadecimal.

Syntax :TRIGger:SPI:SETup:BPATtern:HEXa<x>{<String>}
:TRIGger:SPI:SETup:BPATtern:HEXa<x>?
<String>=2 characters by combining '0' to 'F' and 'X'
<x>=1 to 8

Example :TRIGGER:SPI:SETUP:BPATTERN:HEXA1 "1B"
:TRIGGER:SPI:SETUP:BPATTERN:HEXA1? -> :TRIGGER:SPI:SETUP:BPATTERN:HEXA1 "1B"

:TRIGger:SPI:SETup:BPATtern:MODE

Function Enables/Disables Pattern B of the trigger or queries the current setting.

Syntax :TRIGger:SPI:SETup:BPATtern:MODE{<Boolean>}
:TRIGger:SPI:SETup:BPATtern:MODE?

Example :TRIGGER:SPI:SETUP:BPATTERN:MODE ON
:TRIGGER:SPI:SETUP:BPATTERN:MODE? -> :TRIGGER:SPI:SETUP:BPATTERN:MODE 1

:TRIGger:SPI:SETup:BPATtern:PATtern<x>

Function Sets the Pattern B pattern of the trigger at the byte level in binary or queries the current setting.

Syntax :TRIGger:SPI:SETup:BPATtern:PATtern<x> {<String>}
:TRIGger:SPI:SETup:BPATtern:PATtern<x>?
<String>=8 characters by combining '0,' '1,' and 'X'
<x>=1 to 8

Example :TRIGGER:SPI:SETUP:BPATTERN:PATTERN1 "10X10X10"
:TRIGGER:SPI:SETUP:BPATTERN:PATTERN1? -> :TRIGGER:SPI:SETUP:BPATTERN:PATTERN1 "10X10X10"

:TRIGger:SPI:SETup:BPATtern:TRACe

Function Sets the data to be used as Pattern B of the trigger or queries the current setting.

Syntax :TRIGger:SPI:SETup:BPATtern:TRACe{<NRf>}
:TRIGger:SPI:SETup:BPATtern:TRACe?<NRf>=2, 3

Example :TRIGGER:SPI:SETUP:BPATTERN:TRACE 2
:TRIGGER:SPI:SETUP:BPATTERN:TRACE? -> :TRIGGER:SPI:SETUP:BPATTERN:TRACE 2

:TRIGger:SPI:SETup:SPOLarity

Function Sets the edge slope of the clock signal (SCK) of the trigger or queries the current setting.

Syntax :TRIGger:SPI:SETup:SPOLarity{RISE|FALL}
:TRIGger:SPI:SETup:SPOLarity?

Example :TRIGGER:SPI:SETUP:SPOLARITY RISE
:TRIGGER:SPI:SETUP:SPOLARITY? -> :TRIGGER:SPI:SETUP:SPOLARITY RISE

:TRIGger:SPI:SETup:SSEnable

Function Sets the enable state of the slave select signal (SS) of the trigger or queries the current setting.

Syntax :TRIGger:SPI:SETup:SSEnable{HIGH|LOW}
:TRIGger:SPI:SETup:SSEnable?

Example :TRIGGER:SPI:SETUP:SSEENABLE HIGH
:TRIGGER:SPI:SETUP:SSEENABLE? -> :TRIGGER:SPI:SETUP:SSEENABLE HIGH

2.8 Communication Commands

:TRIGger:TYPE

Function Sets the trigger type or queries the current setting.

Syntax :TRIGger:TYPE {ABN|ADB|PATTern|
WIDTH|OR|TV|SIMPlE|SPIBUS}
:TRIGger:TYPE?

Example :TRIGGER:TYPE SPIBUS
:TRIGGER:TYPE? ->
:TRIGGER:TYPE SPIBUS

3.1 I²C Bus Signal Analysis Function

Applicable Bus

Item	Specifications
I ² C bus	Bus transfer rate: Up to 3.4 Mbits/s Address mode: 7 bits
SM bus	Conforms to the System Management Bus.

Trigger Function

Item	Specifications
Trigger source	CH1: SCL CH2: SDA CH3 to CH4: Analog signal input
Start/Stop conditions for I ² C bus signal trigger	Select the start/stop conditions from the following: <ul style="list-style-type: none"> Ignore/Not ignore restart conditions Ignore/Not ignore start/stop conditions that do not conform to the protocol
I ² C bus signal trigger	Select from the following two trigger types. <ul style="list-style-type: none"> Address&Data: Activates the trigger based on the comparison of the specified address and data. Non-ACK: Activates a trigger when an acknowledge is not present. <p>For Address&Data trigger, a trigger is activated on the combination (AND logic) of the five items below. Start Condition and Byte Count are always applicable (enabled). Address, Data 1 and Data 2 can be enabled or disabled.</p> <ul style="list-style-type: none"> Start Condition: Activates a trigger on the start condition. Address: Activates a trigger on the true/false condition of the result of the comparison with the address (total of 8 bits comprised of the 7-bit address and R\bar{W}). Data 1: Activates a trigger on the true/false condition of the result of the comparison with the data immediately after the address. The length of data that is compared is 1 byte. Byte Count: Activates a trigger at the specified number of bytes after the start condition (after the address if the address is enabled and after Data 1 if Data 1 is enabled). The selectable range is 0 or 9999. Data 2: Activates a trigger on the true/false condition of the result of the comparison with the data that is present after the byte count passes. The length of data that is compared can be set to 1 or 2 bytes. Select whether to compare the data immediately after the byte count passes or continue comparing until the stop condition.
Combination trigger	Possible to activate triggers by combining the CH3 to CH4 analog signals and the I ² C bus signal (CH1 and CH2). <ul style="list-style-type: none"> I²C Only: Activates a trigger only on the trigger conditions of the I²C bus signal. I²C on Pattern: Activates a trigger when the trigger conditions of the I²C bus are met on the true or false condition of the CH3 to CH4 parallel pattern. I²C -> Pattern: Activates a trigger when the trigger conditions of the parallel pattern of CH3 to CH4 are met after the trigger conditions of the I²C Bus signal are met.

Analysis Function

Item	Specifications
Signal input	Select CH1 (SCL), CH2 (SDA) or CH3 (SCL), CH4 (SDA).
Number of data points that can be analyzed	Up to 40000 bytes (20000 bytes before and after the reference point)
Display of the analysis results	Displays the analysis results using the following two methods. <ul style="list-style-type: none"> Waveform and the list of analysis results Simultaneously displays the waveform and the list of analysis results (No. (analysis number), Hex (hexadecimal display of analysis data), and Ack (Acknowledge bit condition)). List of detailed analysis results Displays No. (analysis number and start/stop conditions), Time (time from the analysis reference), Binary (binary display of the analysis data), Hex (hexadecimal display of analysis data), and Ack (Acknowledge bit condition).

3.1 I²C Bus Signal Analysis Function

Search Function

Item	Specifications
Data search	<p>The following two types of search are possible. However, they cannot be used simultaneously.</p> <ul style="list-style-type: none">• Pattern search (Byte Pattern) Set the address pattern, data pattern, and Acknowledge bit condition and search the waveform. If a waveform that matches the condition is found, the zoom box moves to that point and displays the specified waveform.• Indefinite data search (Indefinite State) Indefinite data can be searched.

Analysis Result Save Function

Item	Specifications
Data storage of the list of detailed analysis results	Saves the list of detailed analysis results to a file in ASCII format (.txt extension).

3.2 SPI Bus Signal Analysis Function

Trigger Function

Item	Specifications
Trigger source	CH1: SCK CH2: MOSI CH3: MISO CH4: SS
SPI bus signal trigger	<p>Activates a trigger on the combination (AND logic) of the following four items. Assertion of SS and Byte Count are always applicable (enabled). A Pattern and B Pattern can be enabled or disabled.</p> <ul style="list-style-type: none"> • Assertion of SS: Activates a trigger on the assertion of SS. • A Pattern: Activates a trigger on true/false condition of the result of the comparison with the MOSI data immediately after the assertion of SS. The length of data that is compared can be set to 1 or 8 bytes. • Byte Count: Activates a trigger the specified bytes after the assertion of SS (after the A pattern if A Pattern is enabled). The selectable range is 0 or 1000. • B Pattern: Activates a trigger on the true/false condition of the result of the comparison with the data that is present after the byte count passes. The data to be compared is selectable between MOSI and MISO. The data length can be set to 1 to 8 bytes. Select whether to compare the data immediately after the byte count passes or continue comparing until the negation of SS.

Analysis Function

Item	Specifications
Signal input	CH1: Clock signal (SCK) CH2: Data 1 (MOSI) CH3: Data 2 (MISO) CH4: CS signal (SS)
Number of data points that can be analyzed	Up to 80000 bytes (40000 bytes before and after the reference point)
Analysis Result Display	<p>Displays the analysis results using the following two methods.</p> <ul style="list-style-type: none"> • Waveform and the list of analysis results Simultaneously displays the waveform and the list of analysis results (No. (analysis number), Dt1 (hexadecimal display of the Data 1 value), Dt2 (hexadecimal display of the Data 2 value), and CS (CS signal status or the CS signal name with high precedence). • List of detailed analysis results Displays No. (analysis number), Time (time from the analysis reference point), Dt1 (hexadecimal or binary display of the Data 1 value), Dt2 (hexadecimal or binary display of the Data 2 value), CS (CS signal status or the CS signal name with high precedence).

Search Function

Item	Specifications
Data search	<p>The following two types of search are possible. However, they cannot be used simultaneously.</p> <ul style="list-style-type: none"> • Pattern search (Frame Pattern) Search the waveform by specifying a data pattern. If a waveform that matches the pattern is found, the zoom box moves to that point and displays the specified waveform. • Indefinite data search (Indefinite State) Indefinite data can be searched.

Analysis Result Save Function

Item	Specifications
Data storage of the list of detailed analysis results	Saves the list of detailed analysis results to a file in ASCII format (.txt extension).

Index

A

A Pattern 2-9
 Acknowledge Bit 1-1
 Address & Data Trigger 1-10
 Address Pattern 1-11
 Adrs&Data 1-10
 Analysis Condition 1-31, 2-25
 Analysis Function 1-1, 2-2, 3-1, 3-3
 Analysis Reference Point 1-31, 2-26
 Analysis Result List 1-32, 2-27
 Analysis Result Save Function 3-2, 3-3
 Analyze Setup 1-31, 2-25
 Analyzing Data 1-25, 2-19
 Applicable Bus 3-1
 Assertion of SS(CH4) 2-9

B

B Pattern 2-9
 Bit Order 2-9, 2-26
 Bit Pattern 2-10
 Byte Count 1-11, 2-9
 Byte Pattern 1-34

C

Chip Select Signal 2-26
 Clock Channel 1-13, 1-31
 Clock Signal 2-25
 Combination Trigger 1-12
 Communication Command 1-38, 2-35
 Condition 2-10
 CS 2-26

D

Data Byte 2-10, 2-30
 Data Channel 1-31
 Data Pattern 2-30
 Data1 Pattern 1-11
 Data2 Pattern 1-11
 Detailed List of Analysis Data 1-33, 2-29
 Determination Pattern 2-30

E

Enable State 2-10
 Error Message 1-37, 2-34

F

Flow of Operation 1-2, 2-3
 Frame Pattern 2-30

H

Hysteresis 1-31, 2-25

I

I²C -> Pattern 1-13, 1-24
 I²C Analyze Group 1-38, 1-40
 I²C Bus Signal Acquisition Condition 1-4
 I²C Bus Signal Analysis Function 1-1, 3-1
 I²C File Group 1-39, 1-45
 I²C on Pattern 1-13, 1-23
 I²C Only 1-12, 1-23
 I²C Setup 1-10
 I²C Trigger Group 1-39, 1-46
 I²C Trigger Type 1-10
 Indefinite Data Search 1-34, 2-30
 Indefinite State 1-34, 2-30
 Input Terminal 1-3, 2-4

L

Level 1-31, 2-25

N

Next 1-34, 2-31
 Non-ACK 1-10
 Non-ACK Trigger 1-10

P

Pattern Condition 1-13, 1-14
 Pattern Format 1-11, 2-9, 2-30
 Pattern Search 1-34, 2-30
 Polarity 2-25
 Prev 1-34, 2-31
 Probe 1-3, 2-4

R

Record Length 1-14, 2-11
 Restart Condition 1-12

Index

S

Saving the Data of the Detailed Analysis List	1-35, 2-32
SCL Signal	1-1
SDA Signal	1-1
Search Condition	1-34, 2-30
Search Function	1-1, 2-2, 3-2, 3-3
Search Type	1-34, 2-30
Searching Data	1-25, 2-19
Slope	2-25
Source	2-30
SPI Analyzer Group	2-35, 2-37
SPI Bus Signal Acquisition Condition	2-5
SPI Bus Signal Analysis Function	2-1, 3-3
SPI File Group	2-36, 2-43
SPI Setup	2-9
SPI Trigger Group	2-36, 2-47
Start Condition	1-1, 1-12
Starting	1-14, 2-11
Stop Condition	1-12
Stopping	1-14, 2-11

T

Thr Lower	2-25
Thr Upper	2-25
Threshold Level	1-31
Trigger Condition	1-10, 2-9
Trigger Coupling	1-14, 2-11
Trigger Function	1-1, 2-1, 3-1, 3-3
Trigger Level	1-14, 2-11
Trigger Mode	1-14, 2-11